



ST. JOHN'S
Development
Design Manual
January 2024

DIVISIONS

1	GENERAL INFORMATION	1
2	SURVEYING	11
3	DRAFTING	17
4	EASEMENTS	22
5	TRANSPORTATION	24
6	STORMWATER MANAGEMENT	70
7	SANITARY SEWER SYSTEM	134
8	WATER DISTRIBUTION SYSTEM	146
9	LANDSCAPING	160
10	EROSION AND SEDIMENT CONTROL	190
11	WINTER DESIGN	202
12	FLOODPLAINS	215
13	COMMERCIAL DEVELOPMENT	225
14	WETLANDS	231
15	STREAM CROSSINGS	264

1 GENERAL INFORMATION

1.1 INTRODUCTION

This is the Development Design Manual (known herein as “the Manual”) for the City of St. John’s (known herein as “the City”). Here you will find detailed information about the many design aspects of municipal engineering within the City.

These criteria and design standards together with all future amendments shall be used in the design and construction of all development within the municipal boundaries of the City of St. John’s. All development reports, plans and design drawings that are submitted to the City for review shall comply with the criteria presented herein. This Manual provides the minimum technical criteria for the planning, analysis, and design of development infrastructure. All Subdivisions; Residential, Commercial, Industrial, and Institutional Developments; or any other proposed development which is submitted to the City for review shall include adequate and appropriate development planning, analysis, and design in accordance with the criteria set forth herein. Development planning, analysis, and design that requires technical criteria not specifically addressed in this Manual shall be reviewed by the City on a case-by-case basis. The City, at its sole discretion, may reject any Development plan, analysis, or design if it is not in accordance with this Manual or if the proposed work is deemed to be detrimental to existing properties or infrastructure.

This Manual is intended to cover the design requirements by the City. All designs must conform to City Bylaws, Regulations, and Policies, as well as Provincial and Federal Legislation and Regulations. These include but are not limited to:

- Fisheries Act;
- Navigable Waters Protection Act;
- Wildlife Act;
- Migratory Birds Act;
- Water Resources Act;
- City of St. John’s Act;
- Urban and Rural Planning Act;
- City of St. John’s Municipal Plan;
- City of St. John’s Development Regulations;
- Stormwater Management Policy; and
- City of St. John’s Specification Book

In the case of any disagreement between this Manual and the above listed Bylaws, Regulations, and Policies, the above shall govern.

This Manual consists of fifteen Divisions:

Division 1 – General Information;
Division 2 – Surveying;
Division 3 – Drafting;
Division 4 – Easements;
Division 5 – Transportation;
Division 6 – Stormwater Management;
Division 7 – Sanitary Sewer System;
Division 8 – Water Distribution System;
Division 9 – Landscaping;
Division 10 – Erosion and Sediment Control;
Division 11 – Winter Design;
Division 12 – Floodplains;
Division 13 - Commercial Development;
Division 14 – Wetlands; and
Division 15 – Stream Crossings

1.2 DEFINITIONS

Active Storage – The temporary storage volume provided in a stormwater detention pond. In a wet pond this is the storage between **PWL** and **HWL**.

Approval-In-Principle – A conditional approval of a Development. All conditions attached to the Approval-In-Principle must be met before Final Approval may be granted.

Aquatic Bench – Those shallow areas (0.5m deep) around the edge of a permanent pool of a stormwater detention pond that support aquatic vegetation – both submerged and emergent.

Building – A building means:

- I. a structure, erection, alteration or improvement placed on, over or under land attached, anchored or moored to land;
- II. mobile structures, vehicles and marine vessels adapted or constructed for Residential, Commercial, Industrial and other similar uses;
- III. a part of and fixtures on Buildings referred to in subparagraphs (I) and (II); and
- IV. an excavation of land whether or not that excavation is associated with the intended or actual construction of a Building or thing referred to in subparagraphs (I) to (III); but does not include for the purposes of this Manual:

- a fence
- a utility enclosure

Building Permit – A separate application and review, by Regulatory Services Division, for a permit to: construct a new dwelling; add an extension to an existing dwelling; demolish a structure; demolish and rebuild a structure; structural repairs; erect a deck; build a fence; construct an accessory building; or any other general site work.

CAD – Computer Aided Design

City – The Corporation of the City of St. John's or the municipal area comprised within the boundaries of The Corporation of the City of St. John's, as the context may require.

Coordinate Survey System – A provincial system established for referencing land surveys and is based on Zone 1 of the Newfoundland 3° (degree) Modified Transverse Mercator Projection (MTM) and the North American Datum of 1983 (NAD83).

Coordinate Monument – Any City of St. John's approved marker established for the Coordinate Survey System. Markers shall be intervisible and placed in sidewalk or curb.

Detention storage – The temporary storage and controlled release of stormwater from a stormwater detention facility.

Developer – Any individual, agent, corporation, or legal entity engaged in the development of land.

Development – Means the carrying out of building, engineering, mining, or other operations in, on, over, or under land, or the making of a material change in the use, or the intensity of use of land, buildings, or premises and the:

- I. making of an access onto a highway, road, or way;
- II. erection of an advertisement or sign;
- III. construction of a Building; and
- IV. the parking of a trailer, or vehicle used for the sale of refreshments or merchandise, or as an office, or for living accommodation;

And excludes:

- V. carrying out of works for the maintenance, improvement, or other alteration of any building, being works which affect only the interior of the Building or which do not materially affect the external appearance or use of the Building;

- VI. carrying out by a highway authority of any works required for the maintenance or improvement of a road, being works carried out on land within the boundaries of the road reservation;
- VII. carrying out by a local authority or statutory undertakers of works for the purpose of inspecting, repairing or renewing any sewers, mains, pipes, cables or other apparatus, including the breaking open of a street or other land for that purpose; and
- VIII. the use of a Building or land within the courtyard of a dwelling house for a purpose incidental to the enjoyment of the dwelling house as a dwelling.

For the purposes of this Manual, Development also includes excavation, land clearing, grubbing, and the subdividing or consolidating of parcels of land.

Easement – A right of use over and/or under a property of another.

Final Approval – A Development that has submitted all plans, studies, computations for review; the City has reviewed the same and is satisfied that all City requirements have been met; all fees, assessments, and securities have been paid to the City in a format acceptable to both the Finance and Administration Department and the Office of the City Solicitor; and any Development Agreements have been signed by the Developer, the City, and executed.

HWL – The highwater elevation in a stormwater detention wet pond for the 100-year event.

Inactive Storage – Often referred to as “dead storage”, it is the volume of water in a stormwater detention wet pond between the bottom of the pond and the **PWL**.

Infrastructure – Means any system, facility, service, or utility which is required by this Manual and includes, without limitation: potable water supply and distribution; sanitary sewage collection and disposal; stormwater management collection and disposal – including floodproofing and stormwater drainage facilities; street construction (including clearing and grubbing, material removal/placement, subbase preparation, road granulars placement, asphalt placement, installation of curb/gutter/sidewalk, installation of medians/boulevards/boulevard crossings, street lights, landscaping, street trees, line painting, etc.); supply and distribution of electricity, telephone, telecommunications, internet, broadband access, Fiber Op and cable TV; along with devices required to control drainage, erosion, and sediment during the construction process.

Legal Survey Plans and Descriptions – A diagram and written account describing the limits of a parcel or a boundary delimitation prepared by a member in good standing of the Association of Newfoundland Land Surveyors (ANLS). The Plan and Description shall identify all interests or encumbrances in title and delineate any encroachment over the boundary of the subject parcel or onto adjacent parcels.

Overland Flow Route – Means a route where overland flow is directed away from a stormwater management system.

PERS - Department of Planning, Engineering and Regulatory Services, City of St. John's.

Permanent Pool - The portion of a stormwater detention wet pond which retains a permanent volume and depth of water.

PDF – Portable Document Format

Private Access – Any privately owned driveway which connects to a public street.

PWL - The permanent water elevation created by the inactive storage of a permanent pool.

Right-Of-Way – Limits of publicly owned street, laneway, or right of passage over land.

Sanitary Sewer Main – A public closed conduit which conveys wastewater flow and which is located within a public Right-Of-Way or dedicated public sanitary sewer Easement.

Sanitary Sewer Service Lateral – A private sewer pipe that connects a building sewer to the Sanitary Sewer Main that is located within the public Right-Of-Way or public Easement.

Sediment Forebay – A permanent pool that is designed to facilitate maintenance and improve sediment removal by trapping larger particles near the inlet of a stormwater detention pond. The forebay is designed to be the deepest area of the pond to minimize the potential for particle re-suspension and prevent conveyance of the suspended material to the outlet.

Subdivision – A Development of lands with two or more lots.

Survey – The determination of any point or the direction or length of any line required in measuring, marking off or dividing land for the purpose of establishing boundaries or title to land. All survey work shall be completed in accordance with the By-Laws and Manual of Practice of the Association of Newfoundland Land Surveyors (ANLS).

Wetlands – Those areas that are inundated or saturated by surface or ground water at a frequency and duration sufficient to support, and that under normal circumstances do support, a prevalence of vegetation typically adapted for life in saturated soil conditions. Wetlands generally include bogs, fens, marshes, swamps, and shallow open water.

1.3 DEVELOPMENT APPLICATION PROCESS

In general, the development process follows Figure 1-1

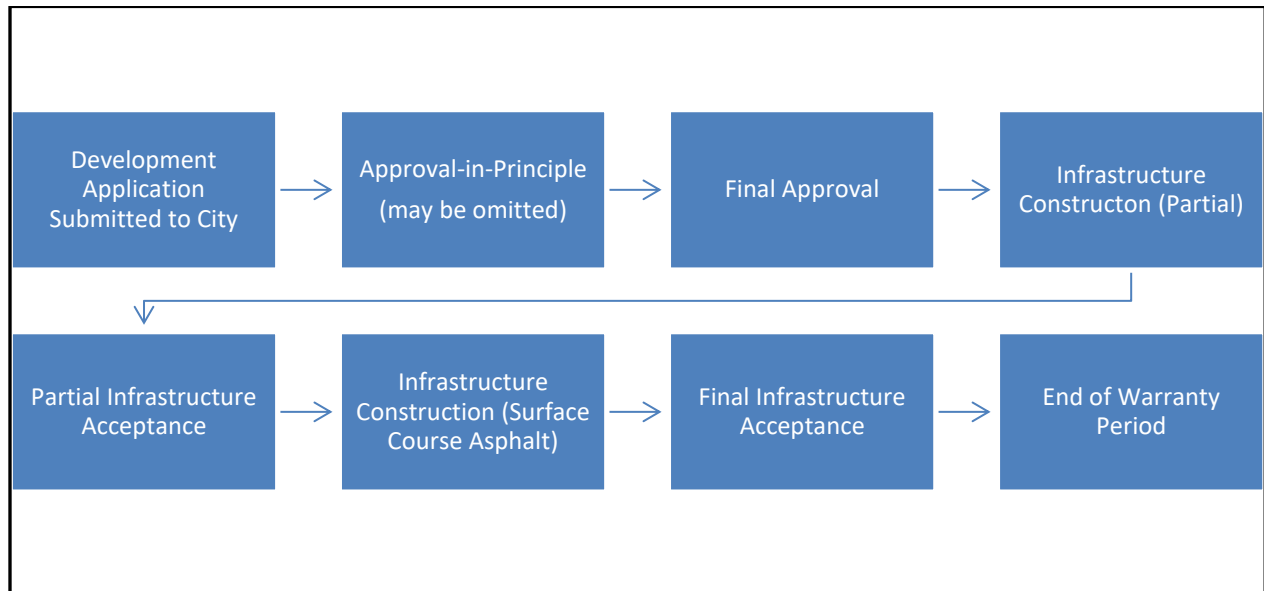

Figure 1-1 - Development Process

1.3.1 APPROVAL-IN-PRINCIPLE

Developers may submit an application and concept plan for Approval-In-Principle showing the layout for the proposed Development which addresses the following:

- Access;
- Internal street layout;
- Lot layout;
- Point of connections for water supply, sanitary sewer, stormwater management and utilities;
- Snow storage; and
- Tree planting/Landscaping.

An Approval-In-Principle does not constitute Final Approval of a Development. All applicable standards must be met prior to the issuance of Final Approval. Final Approval is required before Development may commence.

1.3.2 FINAL APPROVAL

Developers will submit a Development Application to PERS and provide all information required by the City, including but not limited to the following for review:

- Legal Survey Plan and Description (current Real Property Report may be required);
- Draft Subdivision Plan;

- Lot Grading and Driveway Location Plan;
- Landscape Plan;
- Snow Storage Plan and calculations;
- Plan and Profile drawings with appropriate details;
- Sanitary sewer spreadsheet computations (in Excel Spreadsheet format);
- Storm sewer computations (in Excel Spreadsheet format or SWMM model compatible with City software);
- Water supply spreadsheet computations and model (if required);
- Sediment and Erosion Control Plan;
- Rodent Control Plan;
- Federal Government Approvals;
- Provincial Government Approvals; and
- Canada Post Approvals.

All Engineering drawings must be signed by a Professional Engineer licensed to practice in Newfoundland and Labrador and contain a valid Permit to Practice stamp for the current year.

All Landscape Plans must be signed by a Landscape Architect licensed to practice in Newfoundland and Labrador.

Further submittals may be required depending on the type of development and outcome of staff review.

Final Approval shall not prevent the City from thereafter requiring the Developer to correct any errors or revisions to items that were not identified at the time of review.

Revisions to the approved plans shall not be made without the prior approval of the City. Prior to approval, appropriate drawings, plans, and/or calculations shall be submitted for review to PERS.

Developers may receive Final Approval provided the following is met:

- All applications, plans, calculations, approvals have been submitted and approved by PERS.
- All approvals of other agencies have been provided.
- Development fees and assessments are paid in full.
- Securities are submitted to the satisfaction of the City (See Section 1.4).
- Development Agreement signed by all parties, if applicable.
- An official signed letter from the City has been issued authorizing permission to commence construction.

1.3.3 INFRASTRUCTURE CONSTRUCTION AND ACCEPTANCE

The Developer shall be responsible for design, construction, inspection, testing, and commissioning of all infrastructure required to support the Development and as outlined in the Development Agreement.

No excavation, placement of fill, changing of grade, construction, or installation of any kind shall be performed until Final Approval has been issued, unless otherwise approved by the City.

Once the Developer receives Final Approval, they can begin Infrastructure Construction, which includes:

- Installation of water, sanitary, and storm sewer systems;
- Construction of all public and private detention and drainage infrastructure;
- Construction of all street rights-of-way complete with line painting;
- Installation of sidewalk, curb & gutter;
- Installation of street lighting;
- Development of Open Space areas and accesses to these areas;
- Landscaping and tree planting;
- Installation of privacy fencing;
- Construction of walkways; and
- Conveyance of street Right-Of-Ways, Easements, and Open Space.

All works are to be done in accordance with the approved design plans. Any changes are to be approved by the Manager of Development Engineering prior to construction.

Note that Infrastructure Construction is not considered to be complete until surface course asphalt is placed. Surface course asphalt shall not be placed in a Development until approval to proceed is given by the City, which is to be the earliest of 5 years following base course placement or at such time when 80% of structures in the Development are completed to the drywall stage.

Once all infrastructure is complete, with the exception of surface course asphalt, the Developer can seek Partial Acceptance to move forward with Building Permits. Building Permits will not be issued prior to Partial Acceptance, unless otherwise approved at the discretion of the City.

For Partial Acceptance, the Developer must submit for review and approval the following documents:

- As-built engineering drawings;
- As-built Subdivision Plan;
- House Service Information Form for each approved building lot;
- Video inspection of the storm and sanitary sewer systems;
- Video inspection analysis report;
- Asphalt tests (base course);

- Concrete tests for curb, gutter, and sidewalk;
- Sanitary sewer test reports (watertightness, deflection, exfiltration);
- Verification from City Inspectors that the water system has been swabbed;
- Verification that the water system has been chlorinated;
- For Commercial Development, stamped letter from the Developer's Engineer indicating that all site work has been completed in accordance with the approved plans and City of St. John's Specification Book;
- Legal plans and descriptions of street Right-Of-Ways, Easements, and open spaces;
- Benchmark information;
- Water System test reports (pressure/leakage); and
- Other documentation as requested by the City.

City staff will perform an in-house review of all documentation along with field inspection. All deficiencies must be corrected. Once the review and inspections are complete and acceptable to PERS, the City will issue Partial Infrastructure Acceptance.

Once Partial Acceptance is issued, a Warranty Period will apply on all infrastructure until the time of surface course asphalt placement. The Developer will be fully responsible for any damage, defects, or deficiencies during the Warranty Period. The City will not be responsible for damage caused by Builders and correction of any such damage shall be the responsibility of the Developer.

At time of surface course asphalt placement, the City will conduct an inspection. The Developer is responsible for correcting any items identified during the inspection prior to placement of surface course asphalt. The City will note any deficiencies after Infrastructure Construction is complete which need to be resolved prior to Final Infrastructure Acceptance.

Final Infrastructure Acceptance can be considered once surface course asphalt is placed and all asphalt tests and reports are submitted to the City for review.

There is a minimum one-year Warranty Period on surface course asphalt following Final Infrastructure Acceptance. The Developer is responsible for requesting inspection at the end of the Warranty Period. The Developer will be fully responsible for correcting any defects or deficiencies prior to final release of security.

1.4 SECURITIES

Prior to Final Approval, the Developer must submit securities in the format acceptable to the City.

The Developer shall estimate the quantities for the entirety of the Development following the items and divisions in the City of St. John's Specifications Book. The Developer shall submit the estimate to the City in Excel and PDF format. The City shall review the quantities and modify as required to ensure consistency with approved plans. The City

shall apply its own unit prices to determine the overall Development cost. The Development cost shall be factored by 15% for Engineering Fees and 20% for Contingency. The cost, fees and contingency shall be further factored by 4% for the portion of HST for which the City received no reimbursement. **The Developer shall provide a single security in the amount of 50% of the factored Development cost.** This security will serve as both the Subdivision and Maintenance securities as defined in the City of St. John's Development Regulations. Additional securities may be required at the discretion of the City.

A partial refund/release of security may be made at the point of Final Infrastructure Acceptance. The partial refund/release will be as determined by PERS but shall not exceed 90% of the total security held. The remainder of the security shall be held for a warranty period of at least one year. After the warranty period has expired, the City will perform a Final Inspection and advise of any warranty work which must be remediated to the City's sole satisfaction before the remaining security is released.

2 SURVEYING

This Division outlines the requirements for Legal Survey Plans and Descriptions for all development. Land Surveying shall be certified by a Licensed Newfoundland Land Surveyor in good standing (ANLS).

2.1 LEGAL SURVEY PLAN

A Legal Survey Plan shall conform to the Association of Newfoundland Land Surveyors Act, Regulations, By-Laws and Standards of Professional Conduct Knowledge and Skill (SPCKS) and include, but is not limited to, the following:

- I. The name and Provincial Registry of Deeds, Crown Land grant, quieting of title information as the case may be, for the current Owner(s) of all adjoining lands;
- II. The bearing and distance of each line of any traverse which connects any point on the boundary of the lot(s) with a Provincial Horizontal Control Monument;
- III. Where possible, approved street names and civic numbers;
- IV. Each lot and its numbers, walkways, rights-of-way, and Easements;
- V. The bearing and distance of each line of the boundary of, and the area in square meters to the nearest tenth, of:
 - a) The lot or any land being subdivided;
 - b) Each street, walkway, Right-Of-Way and Easement;
 - c) Each lot; and
 - d) The width to the nearest centimeter, of each street.

2.1.1 SIZE OF PLAN

The Legal Survey Plans shall be of a size within the following limits:

Subdivision Plans

- I. **MAXIMUM** - to be approved by PERS.
- II. **Recommended Minimum**

ISO A1	23.4in x 33.1in
--------	-----------------

Lots / LEGAL SIZE

ISO A2	16.5in x 23.4in
ISO A3	11.7in x 16.5in

2.1.2 SCALE

A Legal Survey Plan shall be drawn at an appropriate standard scale, where all text shall measure not less than 2mm height.

2.1.3 CURVED LINES

The radius, arc length, chord length, and chord bearing of each circular curve forming any boundary shall be clearly indicated on the Legal Survey Plan or as specified by the ANLS SPCKS.

2.1.4 CERTIFICATION OF LEGAL SURVEY PLAN

A Legal Survey Plan shall be certified by a Newfoundland Land Surveyor who is a member in good standing with the Association of Newfoundland Land Surveyors.

2.1.5 NORTH ARROW

A north arrow shall be placed on the Legal Survey Plan.

2.1.6 CO-ORDINATION

The Legal Survey Plan shall show a minimum of two Newfoundland and Labrador 3° (degree) Modified Transverse Mercator Projection reference monuments and their NAD83(original) coordinate values.

2.1.7 TITLE BLOCK

The title block for the Legal Survey Plan shall be on the right-hand or bottom side of the plan.

2.1.8 ORIENTATION

Legal Survey Plan shall always be easily readable when viewed upwards from the bottom edge of the plan.

2.2 LEGAL SURVEY DETAILS AND PRECISION

2.2.1 ADJUSTMENT

Survey observations including GNSS shall be adjusted in accordance with the ANLS standards.

2.2.2 PRECISION

All boundary line dimensions to be expressed in meters to three decimal places with adjusted bearings in degrees, minutes, and seconds. All distances shall be adjusted horizontal ground distances unless a note is made to indicate another type of linear measurement.

More or less distances shall only be accepted along a water boundary. Also, when an irregular natural feature (i.e. water body, etc.) forms or references a boundary, a straight line bearing and distance (chord line) from one end of the boundary to the other end shall be shown.

2.2.3 CONTOURS

Contours shall be shown to determine the proper elevations for all streets, roads, Easements and walkways in relation to the proposed lot layout.

For street or streets proposed in undeveloped areas, contours may be taken from the latest issue of the City of St. John's ArcGIS contour mapping shape files.

For that Section of a proposed access street, being within 150m of the existing streets, and which leads into an undeveloped area, the existing vertical alignment conditions (contours) shall be obtained from actual field surveys.

2.2.4 DATUM

All Vertical Control shall be related to City of St. John's Approved Datum. All Horizontal Control shall be related to the North American Datum of 1983 (NAD83(original)).

2.2.5 REQUIRED LEVEL OF DETAIL

Information shown on a Legal Survey Plan shall be sufficiently detailed to permit any point on any surveyed line to be accurately located in the field.

2.2.6 ACCURACY OF CLOSURE

The accuracy of closure shall be not less than 1:10,000 or as specified by the ANLS standards.

2.3 STREET AND LOT IDENTIFICATION

2.3.1 FIELD IDENTIFICATION OF POINTS

When the roadway and street (street line to street line) have been constructed and the lot, subdivision or area involved is ready for acceptance, each public lot, Easement, walkway, Right-Of-Way, and street shall be identified by an iron bar not less than 12 mm in

diameter driven into the ground at each corner, beginning of a curve, and end of curve, unless these points fall upon solid rock. In such cases, an "X" shall be cut into the rock.

2.4 SURVEY INFORMATION

2.4.1 DOCUMENTATION

Prior to infrastructure acceptance, a copy of all information, regarding permanent lot or subdivision survey coordinate monuments, street lines, boundary lines, Easement, Right-Of-Way, and walkway locations, shall be presented to PERS in and hardcopy format. Digital format shall consist of both PDF and AutoCAD 2010 or later files which are compatible with City of St. John's software.

2.4.2 CERTIFICATION

Survey information shall be clear, concise, neat and accurate, properly labelled and certified by a Newfoundland Land Surveyor who is a member in good standing with the Association of Newfoundland Land Surveyors (ANLS).

2.5 BENCHMARK (BM) MONUMENTS

The City of St. John's shall supply brass plugs and wedges or other markers to be used as Monuments.

The City of St. John's shall assign numbers to the Monuments.

The plugs with wedges shall be placed in the concrete curb flush with the concrete. Prior to setting, the plug hole will be filled with quick-set cement. Then, with the use of a mallet and a wooden block, the plug and wedge will be driven into the hole.

All Monuments shall be placed so that they are inter-visible. Care shall be taken not to position plugs in line with objects which may interfere with inter-visibility in the future such as fences, trees, shrubs, utility poles, and so on.

Benchmarks shall not be placed in low back curbs as occupying this point may interfere with entering or exiting of driveways.

All Monuments shall be coordinated using the 3° (degree) Modified Transverse Mercator projection and North American Datum of 1983. The traverse closure shall be a minimum of 1:10,000. Provincial Geodetic reference monuments and their coordinate values shall be listed when running the traverses.

The maximum distance between Monuments shall be 300 meters.

Benchmarks must be established from approved Geodetic Benchmarks and the leveling loops must end at the same or different Geodetic Benchmarks that have acceptable

elevation values (ie. Monuments verified). All lines beginning and ending at existing Benchmarks with known elevations and all lines forming self-closing loops will be leveled one way. All Benchmarks must be turning points and form part of the leveling loop.

Benchmarks must be established by spirit levels, to third order standards with a minimum accuracy of 24 mm/k where k is the distance in kilometers between Benchmarks measured along the leveling route. If the misclosure or discrepancy exceeds the allowable, the line shall be re-leveled.

The method used for leveling will be the three-wire method (mean of the reading of the three wires). To reduce the reading error due to the deviation of the line of sight from horizontal, care shall be taken to keep the backsight (B.S.) and foresight (F.S.) distances as equal as possible for each position of the level and less than 30 meters. Use the following equation to check for errors in readings.

$$\sum B.S. - \sum F.S. = \text{the difference in elevation}$$

Alternate methods of observation may be used including GNSS positioning however, the Developer shall ensure that the same relative accuracy and precision are maintained for the observation methods selected.

The Developer will perform all necessary adjustments of the level loops. The original notes for horizontal control, vertical control and completed description sheets including the method use for any adjustment and the corresponding results shall be submitted to the City of St. John's.

All original field notes shall be on loose leaf paper (100 mm x 165 mm) with the cover sheet showing the name of the firm, date, name or observer, and recorder.

The Developer shall use description sheets based upon a description template sheet supplied by the City of St. John's.

The description sheets shall show the approved street names and civic numbers.

The reference plan of the description sheet shall show a minimum of three (3) ties which radiate so as to place the benchmark at the center. The reference ties shall intersect as close as possible to 120° (degrees) with the benchmark.

The description sheet shall not use ties in excess of 30 meters on the reference plan, however longer ties are acceptable on the key plan.

Benchmark reference ties shall be horizontal and to objects which are above ground and most identifiable first, such as house corners, hydrants, and utility poles. Ground level objects such as manholes, water valves or catch basins shall be treated as a secondary

source as these are often buried during winter or otherwise obstructed. Intangible objects such as boundary corners shall never be used as reference ties.

The description sheets shall be prepared in a fashion that will produce clear and legible copies. The reference plan does not have to be to scale, however, all information shall be digital in a form compatible with the City of St. John's software. Lettering shall be a minimum of 2.5 mm high.

All Monuments and Monument information shall be shown on the Subdivision Plan according to City of St. John's standards.

If the work does not meet the above criteria, the Developer's work shall be returned for correction.

3 DRAFTING

This Division outlines the drafting requirements for all documents related to development.

3.1 PLAN PREPARATION

3.1.1 PLANS

All plans shall be computer generated using the latest version of AutoCAD Civil 3D.

3.1.2 SIZE OF PLANS

Subdivision Plans, Plan & Profile drawings, Grading Plans, Detail Sheets, Drainage Area Plans, etc. shall follow the following size criteria.

- I. **MAXIMUM** - to be approved by the City
- II. **MINIMUM** – ISO A1 - 23.4in x 33.1in

3.1.3 SCALE OF PLANS

The scale of various plans shall be as follows:

- I. Subdivision Plans and Grading Plans
1:500
- II. Engineering Plan & Profile Drawings
 - a) Plan Section - 1:500
 - b) Profile Section - ratio of vertical to horizontal of 1:10
 - c) Cross-Sections and Detail Drawings shall be drawn at a scale that clearly illustrates, at the sole discretion of the City, the subject matter.
- III. Drainage Area Plans
 - a) 1:500
 - b) 1:1250, or
 - c) As approved by the City

3.1.4 GRID SYSTEM

All plans shall show the 3° Transverse Mercator Projection grid system.

3.1.5 PLAN ORIENTATION

Plans shall be drawn in such a manner that they may be viewed either in a west to east or a south to north direction.

3.1.6 DRAFTING SYMBOLS

Standard City of St. John's drafting symbols shall be used on all plans. Where no standard symbols exist for an item, the symbol and its meaning shall be clearly indicated in the plan legend.

3.1.7 LETTERING

All lettering shall be computer generated with font size not less than 2mm high.

3.1.8 TITLE BLOCK

The title block for the project shall be located on the right side of the plan.

3.2 GENERAL CONDITIONS

3.2.1 STREET NAMES

All existing streets shall be clearly identified. Proposed streets shall be identified by an alphabetical designation. Street names shall conform to the City's Street Naming and Civic Addressing Policy.

3.2.2 MATCH LINES

Where the drafting of proposed streets or utilities is continued on other engineering drawings, the following note shall be shown at the match line:

For Continuation
See Sheet No. _____

3.2.3 GRADIENTS

Percentage of gradient shall be shown for all appropriate services to two (2) decimal places. Percentage of gradient shall be shown for finished street centerlines to one (1) decimal place.

3.2.4 HORIZONTAL CURVES

The following horizontal curve information must be shown where appropriate on the plan Section of all engineering drawings. The horizontal curve information must be located in such a manner that it is apparent to which curve the information applies.

- I. Angle of deflection;
- II. Radius of curvature, in meters;
- III. Length of tangent, in meters; and
- IV. Length of curve, in meters.

In addition, the stations of the Beginning of Curve (BC) and End of Curve (EC) must be indicated at the appropriate locations along with their respective NAD83 Northing and Easting coordinates.

3.2.5 VERTICAL CURVES

The following vertical curve information must be shown where appropriate on the profile Section of all Engineering drawings. The vertical curve information must be located in such a manner that it is apparent to which curve the information applies.

- I. Station of the vertical point of intersection;
- II. Elevation of the vertical point of intersection, in meters;
- III. Length of the vertical curve, in meters;
- IV. Gradients of both approaches to vertical curve; and
- V. K Value.
where $K=L/A$,
L = length of vertical curve, in meters,
A = algebraic difference in approach gradients (%).

3.2.6 ACCURACY OF DIMENSIONS

The accuracy of dimensions shall be as follows:

- I. Stationing to the nearest millimeter;
- II. Horizontal distances to the nearest centimeter; and
- III. Elevations to the nearest centimeter.

"More or Less" dimensions shall not be accepted, except along a water boundary or other irregular boundary, in which case a "tie line" between the adjoining boundary end points shall show the bearing and the distance.

3.2.7 DATUM

All elevations shall be referred to the City of St. John's Datum. The location, description, and elevation of the reference Benchmark shall be indicated on the drawing.

3.2.8 REVISIONS

When any plan or drawing is revised, the date of revision and the initials of the draftsman performing the revision must be noted in the appropriate section of the title block. This applies to any revisions made either pre-tender or post-tender. The revision identification number must be placed on the drawing in the area of the drawing that is affected by the revision.

3.2.9 SEALING OF PLANS AND DRAWINGS

Prior to Final Approval or release of any permits, all plans and drawings must be signed and dated with the seal of a Professional Engineer licensed to practice in the Province of Newfoundland and Labrador, and contain a valid Permit to Practice stamp.

3.3 AS-BUILT DRAWINGS

3.3.1 GENERAL REQUIREMENTS FOR AS-BUILT DRAWINGS

The as-built drawings must be signed and dated with the seal of a Professional Engineer licensed to practice in the Province of Newfoundland and Labrador and contain a valid Permit to Practice stamp.

3.3.2 SUBMISSION OF PDF AND CAD FILES

All as-built drawings must be submitted in PDF and CAD format. CAD files are required in AutoCAD DWG format georeferenced in the City's NAD83 coordinate system.

3.3.3 AS-BUILT INFORMATION REQUIREMENTS

The following as-built information is required, as a minimum:

- I. Revisions to finished street center-line elevations, if the difference between design and as-built information is greater than 25 mm.
- II. Revisions to type of sidewalk and/or curb and gutter.

- III. Revisions to street cross-sections.
- IV. Revisions to locations, lengths, grades, inverts, and alignment for sanitary sewer manholes and pipes; storm sewer manholes and pipes; and watermain pipes, valves and hydrants.
- V. The location of all hydrants, valves, manholes, catchbasins, ditch inlets, headwalls, chambers, and other appurtenances shall be referenced in a table listing description; NAD83 georeferenced northings and eastings; and top elevation.
- VI. All invert elevations shall be noted for all manholes, catchbasins, ditch inlets, headwalls and chambers, and other appurtenances.
- VII. The month and year of completion of the construction shall be shown on each plan.

4 EASEMENTS

This Division explains the Easement requirements for development.

4.1 EASEMENTS FOR PUBLIC INFRASTRUCTURE

When public infrastructure, including but not limited to sanitary sewers, stormwater management or water system infrastructure is to be installed by Developers at locations other than on City owned property, an Easement shall be granted to the City for such services/systems/infrastructure at no cost to the City.

The Easement Agreement shall contain language restricting private construction and development within the Easement area, subject to the consent and approval of the City.

4.2 PRIVATE EASEMENTS

When a Developer is proposing private infrastructure to be constructed/installed or drainage directed on a third party's property or proposes/requires a shared servicing/access arrangement, the Developer shall obtain all necessary Easements and agreements to support the proposed design prior to approval.

All Easements outlined above shall be submitted to the City for review and approval prior to execution.

4.3 DESIGN

4.3.1 EASEMENT WIDTH

The width of any Easement shall be based upon the type and number of pipes or other infrastructure to be installed in the Easement. Generally speaking, a single pipe shall require an Easement width which is the greater of either: 6 meters; or two times the depth to the invert of the pipe plus 1 meter. Multiple pipes shall require an Easement width equal to the greater of: the maximum distance from the outside of the most remote pipe to the outside of the closest pipe plus 6m; or two times the depth to the invert of the lowest pipe plus the maximum distance from the outside of the most remote pipe to the outside of the closest pipe. The City, in their sole discretion, reserves the right to require Easement dimensions that differ from the above example.

4.3.2 ALIGNMENT

The alignment of any Easement shall be dependent upon the location of infrastructure to be installed and required access to same.

4.4 ACCEPTANCE

All Easements shall be established through a legal instrument as determined and approved by the City Solicitor.

4.5 SURVEYS

The Developer shall be responsible for coordinating, and the costs associated with, all surveys required for any instruments contemplated in this Division, and draft surveys shall be provided to the City for review and approval prior to finalizing same.

5 TRANSPORTATION

Transportation includes the movement of people and goods regardless of the travel mode. This Division outlines the general design requirements for new and retrofit work on transportation links. This Division reflects this holistic view of transportation and supports the direction of the St. John's Municipal Plan.

All permissive design parameters identified are subject to the City's approval based on situational context, in its sole discretion. The City may require adjustments to these parameters based on design context.

5.1 NETWORK DESIGN

Transportation network design should consider travel of people walking, wheeling, and cycling; people using transit; people driving passenger vehicles; and goods movements to provide a flexible community framework.

The City will require active transportation links within a design wherever these connections support active transportation connectivity. Guidance about cycling network design can be referred to in Bike St. John's Master Plan, 2019.

Network design must not be used as a standalone roadway classification measure. The City shall be satisfied that the overall transportation network design is context appropriate and includes design elements that support the intended function of each street, such as active transportation infrastructure and proactive traffic calming measures. Street design shall be in accordance with the goals outlined in St. John's Municipal Plan.

Grid based designs shall be implemented where possible. Networks shall not be designed with dead-end roadways or three legged "T" intersections, unless approved on the basis of necessity, by the City.

Abrupt high angle changes in through road alignment with tight curvature creating poor sightlines shall not be permitted without approval from the City. Intersections that promote network connectivity are preferred at these alignment transitions.

Shared use and/or bicycle infrastructure separated from vehicle traffic must be incorporated into network design as identified in relevant City active transportation planning documents. As part of a complete street network, active transportation links should typically be separated from the road. Mode separation between active transportation users may be required based on the context of the infrastructure proposed. Independent of the street network, active transportation connections through or to private sites may be required to support a complete transportation network that encourages and prioritizes active modes.

5.1.1 OFF-SITE IMPROVEMENTS

Infrastructure improvements outside the property boundaries of the proposed Development may be required if, in the opinion of the City, such improvements are required as a result of the Development.

5.2 TRANSPORTATION ASSESSMENT

All development and transportation projects within the City have an associated impact on the overall transportation system. As the City continues to grow these impacts must be evaluated to ensure that issues are addressed and remediation measures put in place where necessary. In general, a Transportation Impact Assessment (TIA) may be required to fully evaluate a proposed Development when one of the following situations is present:

- a) The Development generates 100 or more trips during either of the peak hours;
- b) The Development proposes access onto a high volume, high speed, or congested roadway;
- c) The Development proposes access at or in close proximity to an intersection or other access;
- d) The Development proposes a new intersection or upgraded control of an existing intersection;
- e) High turning movements are associated with the proposed usage;
- f) High pedestrian activity is expected;
- g) The Development proposes new crosswalks or is in close proximity to existing crosswalks;
- h) The Development includes changes to existing street characteristics such as lane designations, left turn storage bays, or access restrictions; or
- i) Other special transportation concerns are present based on the adjacent community, design details, or specific usage proposed.

Based on the specific concerns and total number of trips generated by and attracted to the Development, one of the three outcomes will be identified by the City for review and approval:

- No Further Study Required;
- Transportation Impact Memo; or
- Transportation Impact Assessment.

For more details, refer to the City of St. John's "**Standard Terms of Reference – Transportation Assessment**".

5.3 TRANSPORTATION LINK CLASSIFICATION

5.3.1 GENERAL

The purpose of the City's road classification system is to set general expectations for different link types. As with any classification system, the division between the classes can be somewhat indistinct. A link may serve more than one function or may transition from one classification to another. Depending on the combination of characteristics present, design criteria may be applied, at the City's discretion, which do not fit neatly into a single defined classification. A context sensitive approach is required in all cases and the City will consider all relevant factors in determining which classification design criteria, or combination thereof, will be applicable to a Development to ensure the link design respects the intended use of the link, the needs of the transportation system, and the feel of the neighborhoods.

5.3.2 BASIS OF CLASSIFICATION SYSTEM

The City of St. John's links classification system divides links into various typical classes primarily based on:

- I. service function (network role, property access, active transportation link);
- II. travel speed and vehicle volume;
- III. traffic control measures; and
- IV. context (adjacent land uses, Right-Of-Way, physical constraints, other neighborhood characteristics).

Currently five broad link classifications are identified. Characteristics of these classes are shown in Table 5-1.

{This Page is Intentionally Blank}

Table 5-1 - Typical Characteristics of Transportation Links

Characteristics	Arterial Streets	Collector Streets	Local Streets	Unique Streets	Active Transportation Links
Transportation Service Function	Traffic movement is of primary importance, accommodate primarily through traffic and traffic destined to major Development nodes. Examples: Kenmount Rd, Topsail Rd., Columbus Dr.	Traffic movement and land access are of more equal consideration, consolidate local traffic and accommodate some through traffic. Examples: Blackhead Rd., Campbell Ave., Penneywell Dr., Mundy Pond Rd.	Traffic movement is of secondary importance, accommodates traffic destined to properties in the area and low volumes of through traffic	Due to the historic nature of St. John's, many streets defy a simple classification. Network function, local constraints, parking, vehicle volume, and access characteristics may vary. Examples of streets that may fall under a unique classification include alleys and laneways. In new Developments unique streets that add overall network value and provide distinct character, accessibility and connectivity may be considered.	Provide a dedicated link in the pedestrian and/or bicycle active transportation network. Examples include links at the end of dead-end streets, plazas, links within or between park space, and pathways.
Land Service Function	Land access is of secondary importance	Traffic movement and land access are of equal consideration, lower density Residential frontage shall be discouraged	Land access is of primary importance. Roadway design elements will vary and reflect the use of land accessed (Residential, Industrial, Commercial, etc.)		General vehicle access is prohibited. These links may provide for maintenance or emergency services access in certain situations.
Parking	On-street parking is tightly controlled and only permitted in certain contexts	On-street parking with potential time of day and day of week restrictions is sometimes acceptable	On-street parking is acceptable in most cases		Vehicle parking is prohibited, pedestrian rest areas and bicycle parking are appropriate.
Flow Characteristics	Uninterrupted flow except at signals, roundabouts, and crosswalks	Interrupted flow	Interrupted flow		n/a
Vehicle Types	All vehicles	All types with possible truck limitations	Passenger and service vehicles; large vehicles may be restricted		Bicycles, skateboards, strollers, mobility aids, etc.
Access Control	High degree of access control	Moderate to low access control	Low to no access control		Connections to adjacent uses or desire lines is encouraged/required ¹
Traffic Calming	Not applicable	Features may be required based on the context of the street	Features may be required based on the context of the street and adjacent land use		Features must be designed in support of the proposed active transportation network

¹A desire line is a direct path of travel for people using active transportation that supports the shortest possible route to a destination. It may be either observed or anticipated.

{This Page is Intentionally Blank}

5.3.3 PRIVATE ACCESSES

The City significantly restricts the use of private accesses. A qualitative test will be applied by the City to determine if a proposed carriageway will be considered a Private Access. This test will include an evaluation as to whether a reasonable person would find the access sufficiently distinct from a public street such that they would not assume it is a public street. This determination is at the sole discretion of the City.

All private accesses must be owned as part of an approved lot and be operated and maintained by a single tenant or a common interest who will remain responsible for the private access in perpetuity. Documentation must be shown to demonstrate that this common interest has been established.

If a private access is requested to service more than one lot, the following conditions shall be satisfied:

- I. The private access will serve four or fewer lots in a large format Commercial or Industrial Development;
- II. A single entity is identified with sufficient interest in the private access to reasonably ensure ongoing maintenance of the access; and
- III. Legal documentation showing mutual access agreements and the single responsible entity are provided.

All private accesses must be designed to a standard acceptable to the City and must meet the requirements in the City of St. John's Development Regulations. Accesses to and circulation aisles within a contiguous parking lot are not considered private accesses.

5.3.4 DESIGN REVIEW

The link classification system provides a baseline from which to determine the appropriate characteristics for a given link design. During the design review process, the City may require that changes be made to better reflect the context and intended function of the link. These changes may include, but are not limited to, requiring parameters to exceed stated minimums, requiring elements to be added or removed, or requiring innovative treatments not covered in this Manual.

Designers are encouraged to review proposed design parameters with the City as early as possible in the design process. This will facilitate review upon completion of the design and reduce the number of design iterations.

5.4 DESIGN CRITERIA

5.4.1 GENERAL

Streets shall be designed to provide accessible, safe, and convenient travel for people of all abilities using all modes of transportation. Balancing the needs of different user groups may result in less priority than historically granted to some forms of transportation. Street design must be context sensitive and accommodate seasonal maintenance requirements.

For specific situations that are not covered by this Manual, Designers are expected to reference recent industry guidelines, standards, or best practices. Geometric parameters not included shall be determined based on guidelines provided in the most recent edition of the TAC Geometric Design Guide for Canadian Roads.

Should a Developer take the position that it is unable to comply with this Section, the City may, in its sole discretion, accept an alternative, context-sensitive design solution. In order for the City to consider an alternative, context-sensitive design solution, the Developer shall, at a minimum, provide the following:

- Identify the requirement that the Developer feels they are unable to comply with;
- Proposed alternative, context-sensitive design solution; and
- Documentation supporting the Developer's proposed solution based on sound engineering principles.

5.4.2 TYPICAL PARAMETERS

Table 5-2 contains design parameters for street design characteristics. The values shown may generally be considered typical for flat terrain.

Table 5-2 - Transportation Link Design Parameters (Part 1)

Design Parameter		Arterial Streets	Collector Streets	Local Streets	Unique Streets	Active Transportation Links
Gradient	Preferred	≤ 6%	≤ 7%	≤ 10%	≤ 6.25%	<5%
	Maximum	10%	12%	12%	12%	5%†
	Minimum	1.0%	1.0%	1.0%	1.0%	1.0%
		Streets/Links shall be aligned such that they traverse along significant grade changes rather than running orthogonal to the gradient.				
Typical Street Reservation Width (See Figure 5-2 to Figure 5-8)		25.0m – 35.0m	20.0m – 30.0m	17.5m – 25.0m	varies	4m – 10m
Minimum radius		180m	90m	50m	50m – 180m	Varies based on purpose and expected users.
Typical Minimum K-value crest vertical curves sag vertical curves		Based on roadway design speed and illumination as per the most recent edition of the TAC Geometric Design Guide for Canadian Roads: <ul style="list-style-type: none"> • Table 3.3.2 (2017 edition) • Tables 3.3.4 and 3.3.5 (2017 edition) 				
		Lower values may be accepted based on context of site, particularly where reduced speeds may be anticipated, with an absolute minimum acceptable value of 4.				

* See Section 5.5 for typical dimensions for various cross-section elements.

† Where active transportation link grade exceeds 5%, the link is not considered accessible. In areas where longitudinal grades must exceed 5%, mitigation measures for people walking, wheeling and cycling are required. These include adding landings, rest areas, handrails, ramps, additional width, and/or improved sightlines. If an accessible active transportation link is not possible, an alternative/parallel accessible route must be identified/provided.

Table 5-2 - Transportation Link Design Parameters (Part 2)

Design Parameter	Arterial Streets	Collector Streets	Local Streets	Unique Streets	Active Transportation Links	
Minimum length of horizontal curvature	3 times design speed	2 times design speed	1 times design speed	varies	Varies based on purpose and expected users.	
	Lane width and design vehicle over track will be considered in situations where the above conditions cannot be met.					
Intersection Spacing	minimum 200m	Minimum 100m	minimum 60m	varies		
	Spacing of signalized intersections not typically less than 200m					
Single Family Residential Driveway	Not permitted	Not desirable	No minimum spacing	varies		
Other Driveway Spacing (including Commercial and Industrial access)	minimum 70m	minimum 35m	minimum 20m	varies		
	Access management/shared access requirements may apply along Arterial and Collector streets; between a driveway access and adjacent intersections the higher end of this design range applies.					
Intersection/ access turn-out Radius	<u>Minimum</u>	8m	5m	4m		1m – 8m
	<u>Preferred</u>	10m	8m	4m		varies
	<u>Maximum</u>	As required for design vehicle in context. May require multi-radius curves and/or channelizing islands.				
	Final radii to be determined by roadway class, roadway function, and design vehicle needs. Large design vehicles may be assumed to over track in adjacent lanes in the same direction in many situations such that radii can be minimized. Effective radii (see Section 5.4.3) shall be used when outside travel lane is wide and/or not immediately adjacent the curb. Effective radius must always accommodate passenger vehicles with no lane encroachment. A larger radius may be required where curb extensions are used.					
Sidewalks	See Section 5.4.14.					
Design Speed (kph)	60 - 80	50 - 60	40 - 50	varies		
	Design speed must equal the posted speed of roadways with a posted speed ≤ 50 kph. Design speed must be 10 km/hr greater than posted speed for roadways with a posted speed > 50 kph. Roadways with posted speeds > 50kph must be approved by the City.					

5.4.3 EFFECTIVE RADIUS

The effective radius on a corner is measured by connecting the edge of the departure lane and the receiving lane with a circular curve, as shown in Figure 5-1. The outermost general traffic lane (shoulder/curb lane) is used in cases of multi lane cross-sections.

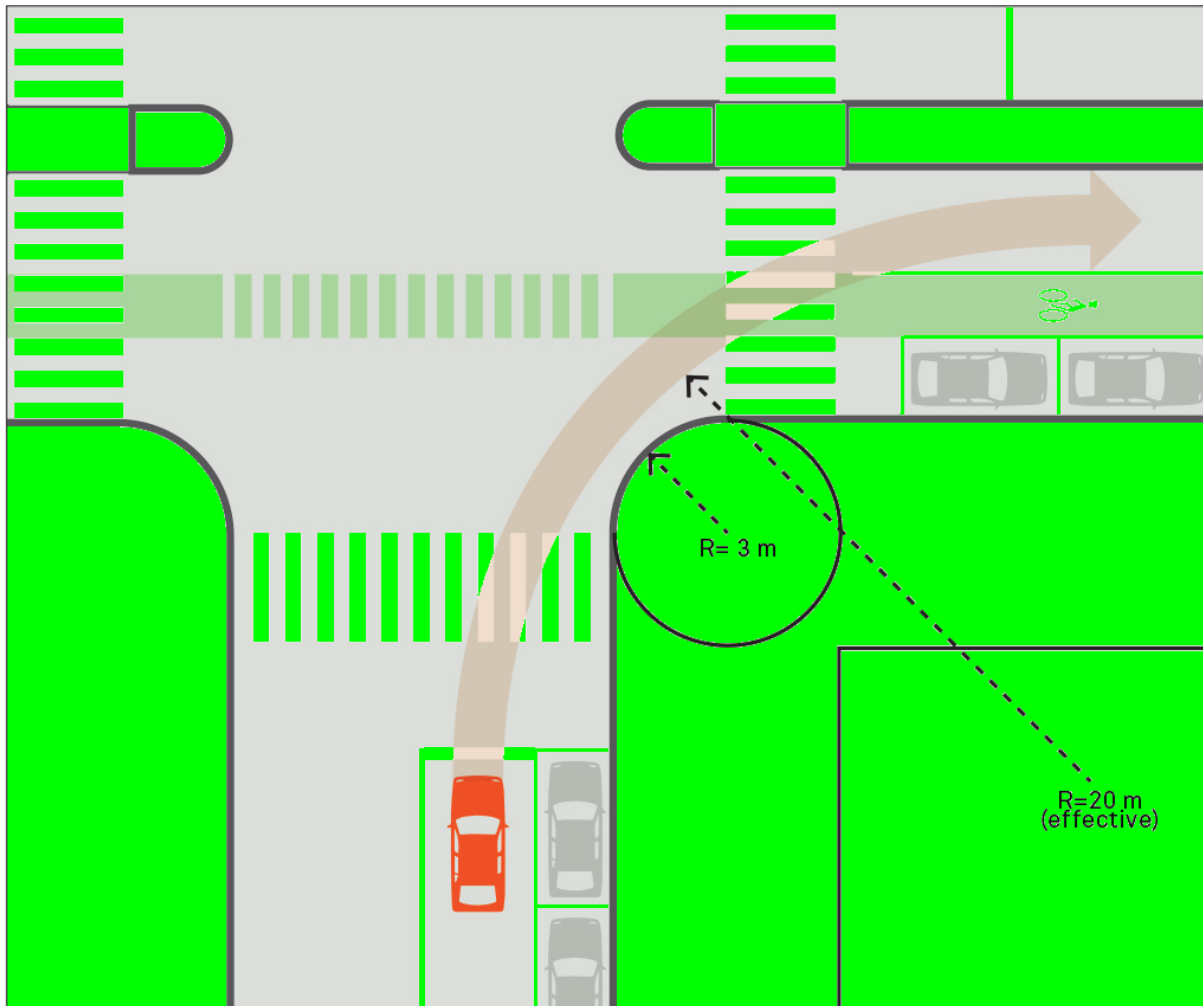

Figure 5-1 - Effective Radius

5.4.4 REVERSE CURVES

The minimum length of tangent between reverse horizontal curves should be 50m.

5.4.5 INTERSECTIONS

For intersections requiring higher degree traffic control than stop or yield control, a roundabout intersection must be considered first. To be used, a traffic control signal must be justified to the satisfaction of the City as more appropriate than a roundabout treatment.

The following criteria apply to street intersections:

- I. An approach leg to an intersection should be designed with a vertical alignment equal to the crown of the intersecting street. This alignment should be maintained for a minimum distance of 10m from a line tangent to the face of curb of the intersecting street. Appropriate vertical curves should then be used to transition to the proposed street grade of the approach leg. This distance may be adjusted if required to ensure that catchbasins are not located within the path of a crosswalk.
- II. The angle of intersection should be 90°. In cases where this is not possible the City may permit a reduction to as low as 75°.
- III. Minimum intersection sight distance must be provided as per the most recent edition of the TAC Geometric Design Guide for Canadian Roads based on roadway design speeds, intersection control, street configuration, or roadway profile.
- IV. Curb extensions are required where an on-street parking lane is on the approach to an intersection. This requirement may be waived in areas where an auxiliary lane is required.
- V. When two or more streets intersect, only one street may have a curved horizontal alignment, all other streets at the intersection should have a tangent section of minimum length of 30 m, measured from the point of intersection of the street lines to the first point of horizontal curvature on the approach street line.
- VI. Turning movement analysis to support intersection design may be required by the City. Intersections must be designed to accommodate appropriate design vehicles as determined by the City.
- VII. Central medians and channelization islands may be required by the City to control turning movements.
- VIII. Where signalized intersection control has been identified, an intersection design including traffic control installations must be submitted to the City for review and approval.

- IX. All new or modified signals shall be designed to an accessible standard including accessible pedestrian push buttons. Dual push buttons at each corner must be provided where possible.

5.4.6 CUL-DE-SACS

Because of the negative effects of cul-de-sacs on the efficiency of service delivery, their use shall be restricted to instances where it is demonstrated to the satisfaction of the City that land access is not possible by through streets. For Commercial Developments, additional factors such as proposed land use and access requirements may be considered, but use of cul-de-sacs will be limited. Ultimately, whether or not a cul-de-sac is an allowable design will be in the sole discretion of the City.

The following additional design criteria apply to cul-de-sacs:

- I. the turning circle radius in the cul-de-sac bulb should be 15.25m at the curb face;
- II. The maximum exit gradient for cul-de-sacs should be +5% (bulb lower than adjacent street) or 12% (bulb higher than adjacent street); this requirement applies to the street gradient beyond the 10 m criterion noted in Section 5.4.5;
- III. Low back curb shall be installed along driveways and along any area between driveways less than 2 m linear;
- IV. The maximum length of a cul-de-sac shall be 200 m, measured along the street centerline from the line tangent to the face of curb of the intersecting street to the start of the turning bulb;
- V. The transitional radius of the street line into the turning circle street line should be 15.25m; and
- VI. An active transportation link shall be provided through the bulb end of the cul-de-sac if any potential travel desire line is identified by the City.

5.4.7 “P” LOOPS

“P” Loop street designs are not permitted in areas zoned for higher density Development and are discouraged as a design practice elsewhere. Under conditions where it can be shown that no secondary access is possible the City may consider the installation of a “P” Loop street.

For the purposes of this Manual, a network configuration that results in lots that only have a single path of travel to the broader street network may be considered a “P” loop (except for cul-de-sacs/dead-end streets).

The maximum length of a "P" Loop street, measured along the street centerline, and including the length of all internal roadways, shall be 850 m. This is measured from the street line of the last street affording access from more than one direction.

The length of the "P" Loop entrance segment shall not exceed 100 m. No more than 50 dwelling units shall be developed on a "P" Loop.

An active transportation link shall be provided through the top portion of the "P" Loop if any potential travel desire line is identified by the City. This link may be at any point along the top portion at the sole discretion of the City.

5.4.8 TEMPORARY SECONDARY ACCESSES

A temporary secondary access shall be provided by the Developer for construction purposes, if, because of the staging of a Development, a situation develops where the ultimate street network is not completed and a length of street greater than 200m exists with only one access to an existing public street at the determination of the City.

The temporary secondary access must have a minimum driving surface width of 6.5m. The driving surface area shall be cleared and grubbed, and any organics or unsuitable material shall also be removed. A minimum subbase thickness of 150mm Class "A" road gravel shall be placed and compacted in accordance with the requirements outlined in the City of St. John's Specifications Book.

Furthermore, a minimum 6.0m width of asphalt shall be placed and compacted to a minimum thickness of 50mm in accordance with the City of St. John's Specification Book. This will provide a 0.25m gravel shoulder on both sides of the temporary secondary access.

A temporary secondary access cannot necessarily be repurposed as a trail and must only be used as a secondary access during the time in which a secondary access is required. If a secondary access is to be repurposed as a trail, it must meet all trail requirements in this document before being used as a trail. Secondary accesses not being repurposed must be removed at Developers expense once a permanent connection is made.

5.4.9 TEMPORARY TURN-AROUND AREAS

A temporary turn-around area must be provided at the end of all streets that are temporarily terminated in dead ends. The temporary turn-around area should have a minimum radius of 15.25m. The temporary turn-around area shall be hard surfaced with a 15m minimum radius of compacted asphalt (minimum thickness = 50mm) and at least 150mm thickness subbase of compacted Class "A" road gravel. This will provide a 0.25m gravel shoulder around the periphery of the temporary turn-around.

5.4.10 CROSS-SECTIONS

Street cross-sections should be generally symmetrical about the street centerline. Dimensions for cross-section elements are identified in Section 5.5.

5.4.11 CROSS-SLOPE

Streets should have a minimum crown of 150mm and cross slope 2% - 4% on tangent section.

Gravel shoulders should have a minimum cross-slope of 4%. Maximum cross-slope shall be 6%.

5.4.12 CURB AND GUTTER

Curb and gutter shall be installed on any street where the longitudinal vertical gradient is less than 2.0% or is in an urban area.

5.4.13 CROSSWALKS AND ACTIVE TRANSPORTATION CROSSINGS

Marked crosswalks and active transportation crossings with enhancements may be required to support proposed active transportation networks. Locations and features required at these crossings will be determined based on anticipated volumes, crossing distance, and network connectivity.

5.4.14 SIDEWALK

City streets must be designed to accommodate travel by the full spectrum of people walking and wheeling including those using mobility aids.

Sidewalks shall be installed on both sides of all urban streets constructed within the City of St. John's except as allowed below:

- I. On cul-de-sacs in R1, RA, or RA1 (Residential low density) zones, having a total length of 200 meters or less, the City may reduce the sidewalk requirement to:
 - a) A single sidewalk along the length of the cul-de-sac where a pedestrian link exists, or is planned, through the bulb end; or
 - b) No sidewalk along the cul-de-sac where no access is possible through the bulb end.
- II. If a street is constructed that, based on existing zoning, is unlikely to serve pedestrian demand, and space within the street reservation is provided for a sidewalk in case of a change in land use, then the City may reduce the sidewalk requirement to:

- a) A single sidewalk in cases where a through demand is likely;
- b) No sidewalk in cases where no pedestrian access is needed and through demand is not likely.

If a single sidewalk is required it shall be constructed on the side of the road, or along another suitable alignment, that promotes the best pedestrian connectivity as determined by the City.

Sidewalks should maintain elevated alignment relative to the roadway surface and should only be ramped down when necessary for the minimum required distance to accommodate driveways/access points.

The City may substitute the requirement for a sidewalk with a requirement for a paved shared-use path. Typically, a 1.8m sidewalk would be substituted with a 3.0m Shared-Use Path.

5.4.15 PATHWAYS

Pathways are formal routes for active transportation. They may be required to connect a site to other sites, streets, trails etc. These pathways may support neighborhood connections as well as serve the potential users of the site. Dimensions vary depending on site characteristics, user groups, and connection needs.

5.4.16 GUIDERAILS

A guiderail must be considered for installation if the finished grade falls at a rate of greater than 1H:4V or an obstacle is located within 5m of the carriageway. If it is determined that a guiderail is not required in these circumstances, then the rationale must be documented within design package. Common reasons that would waive the need for a guardrail are:

- I. The total elevation drop is minimal; or
- II. The obstacle is not isolated but rather part of a consistent cross-section.

Refer to the most recent edition of TAC, Roadside Design Section, for further information on guiderail considerations.

5.4.17 STREET LIGHTING

For simplicity, street lighting designs will be evaluated based on the illumination method. Urban street lighting shall be designed to meet the recommended values in the current version of the TAC Guide for the Design of Roadway Lighting.

Luminaires with the lowest possible up light and backlight rating shall be used to minimize atmospheric light pollution and light spill on adjacent properties.

In rural areas where street lighting is provided recommended lighting levels shall be targeted. If not possible, the average illuminance shall be targeted first then uniformity ratios minimized. For crosswalks, positive contrast and vertical illuminance shall be targeted first.

5.5 DESIGN OF CROSS-SECTION ELEMENTS

5.5.1 GENERAL

In Table 5-3 to Table 5-9 a variety of cross-section elements are identified, and design parameters provided. These cross-sectional elements may be combined to develop a typical cross-section that is appropriate to the context, function, and Right-Of-Way of the street being designed. A typical cross-section for a street does not identify the full extent of street design. For example, variations will occur at intersections for turn lanes, a roundabout, or other treatments. The typical cross-section is intended to demonstrate the normal arrangement of the street along mid-block segments. Detailed plan and profile drawings are required for a complete review of a street design.

All dimensions adjacent to a curb are measured from the face of the curb (inclusive of gutter width).

Curb extensions, truck aprons, channelization islands, accessible sidewalk design and a variety of other street design elements shall be designed as per relevant industry guidance where typical details are not provided by the City and will be approved based on street context and the goals of the St. John's Municipal Plan.

Several cross-section examples are provided in Figure 5-2 to Figure 5-8. These shall not be considered the required or standard application. They are provided to illustrate the ways in which cross-section elements might be provided.

Should a Developer take the position that it is unable to comply with this Section, the City may, in its sole discretion, accept an alternative, context-sensitive design solution. In order for the City to consider an alternative, context-sensitive design solution, the Developer shall, at a minimum, provide the following:

- Identify the requirement that the Developer feels they are unable to comply with;
- Proposed alternative, context-sensitive design solution; and
- Documentation supporting the Developer's proposed solution based on sound engineering principles.

5.5.2 TRAVELLED WAY

The portion of Right-Of-Way intended for the movement of vehicles, transit, and bicycles, often bounded between the two faces of the outside curbs. On sections without curbs, it is the portion between the road shoulders. The space may include center medians or islands.

Table 5-3 - Travelled Way Vehicle Lane Widths

Type	Min (m)	Max (m)	Preferred (m)
Curbside lane ¹	3.4 ²	4.1	3.7 ³
Travel lane	3.0 ²	3.5	3.3 ³
Turn lane/bay	3.0	3.5	3.0
Parallel Parking ^{1,4,5} (Width)	2.1	2.7	2.4
Parallel Parking ^{4,5} (Stall length)	6.0 ⁶	7.5	7.0

Notes:

1. Curbside lane and parallel parking widths are measured from face of curb.
2. Minimum lane widths where buses or larger trucks are expected to use the road regularly are to be 3.7m for curbside lane and 3.3m for travel lane.
3. For Local Residential streets, the preferred value is equal to the minimum.
4. For perpendicular and angled parking, see Table 5-11.
5. For parallel parking where there is heavy vehicle loading, use 2.7m stall width and stall length equal to that of the design vehicle.
6. Parallel parking minimum stall length is suitable for end spaces only.

Bike routes must be designed to be attractive and convenient for people of all ages and abilities. Bike route facility type may vary depending on context. Options for consideration can be found in the 2019 Bike St John's Master Plan.

Table 5-4 - Travelled Way Dedicated Bike Lanes¹

Type	Min (m)	Max (m)	Preferred (m)
One-way ²	1.5	2.1	1.8
Two-way ³	3.0	6.0	3.6
Lane buffer ⁴	0.5	1.2	1

Notes:

1. For shared-use-paths (multiuse trails) see Table 5-7.
2. One-way bike lane may be buffered or protected based on context.
3. Two-way bike lanes shall be protected with vertical elements.
4. Lane buffer may be hatched with paint or include vertical elements such as curbs, barriers, planters, or bollards.

A median physically separates lanes carrying traffic in opposite directions. A median may be required to:

- I. Control access by restricting turning movements;
- II. Reduce risk of head-on collisions; or
- III. Enhance safety for pedestrians by providing a refuge, allowing the street to be crossed in stages.

Table 5-5 - Medians

	Type	Min (m)	Max (m)	Preferred (m)
Median	Separation (Arterial and Collector roads only)	1.5	5.0	3.0
	With trees	5.0	6.0	5.0
	Refuge island	2.0	5.0	3.0

Notes:

1. Median widths are measured from face of curb to face of curb.
2. Hard surfaces must be visually distinct from sidewalk.
3. Hard surfaces to be used where there are benches, bus stops, sandwich boards, planters, bike racks, etc.

5.5.3 PEDESTRIAN REALM

The portion of the Right-Of-Way that is outside of the travelled way.

A boulevard is the portion of land that parallels the roadway between the curb and sidewalk. It serves as a safety separation as well as a location for surface and underground utilities, traffic signs, and other control devices, street trees, transit shelters, and snow storage.

Table 5-6 - Boulevards

	Type	Min (m)	Max (m)	Preferred (m)
Boulevard	No trees	1.5 ²	5.0	3.0 ⁵
	With trees	2.4	5.0	3.5 ⁵
	With street furniture	2.4	5.0	3.5

Notes:

1. Measurements shall be taken from face of curb.
2. In constrained retrofit conditions, boulevards $\leq 1.5\text{m}$ may be considered and are to be hard surface only. To maintain continuous sidewalk elevation where there are driveways, an absolute minimum of 0.6m shall be provided.
3. Hard surface must be visually distinct from sidewalk.
4. Hard surface to be used where there are benches, bus stops, sandwich boards, planters, bike racks, etc.
5. For Local Residential streets, the preferred value is equal to the minimum.

Shared-use paths (Multiuse Trails) are intended for users of different types (e.g. pedestrians and cyclists) and allow two-way travel for all modes.

Table 5-7 - Shared-Use Paths (Multiuse Trail)

Type	Min (m)	Max (m)	Preferred (m)
Shared-use path (Multiuse Trail)	2.7	5.0	3.0 ¹

Notes:

1. Separate bike and pedestrian facilities shall be considered when there are greater than 100 person per hour.
2. Paths shall have a smooth paved surface.

Sidewalk is intended for pedestrian use only. For additional information on sidewalks refer to Section 5.4.14.

Table 5-8 - Sidewalks

	Type	Min (m)	Max (m)	Preferred (m)
Sidewalk	Arterial/Collector/Local Street	1.8 ¹	N/A	1.8
	Main Street/ High Activity Area/Downtown/School Zone	2.1	N/A	3.0
	Plaza	3	N/A	varies

Notes:

1. For Local Streets only where there are constraints the minimum sidewalk width may be reduced to 1.5m

Right-Of-Way buffer is measured from the back of sidewalk to the property line in urban cross-sections. It provides clearance to the edge of Right-Of-Way, provides space for future grade adjustments, and may be used to accommodate surface utilities.

Shoulders are provided on rural cross-sections. They are continuous with the travelled way and intended for emergency stopping and/or lateral support of the roadway structure. They may be configured to be accessible for bicycle travel.

Table 5-9 – ROW Buffers and Shoulders (Roads with Rural Cross-Sections)

	Type	Min (m)	Max (m)	Preferred (m)
Right-Of-Way buffer	Landscaped	0.3 ¹	2.0	1.0
	Hard Surface	0.3 ²	3.0	1.0
Shoulder ³	Paved	1.5	2.4	1.8
	Gravel	0.6	2.4	0.6

Notes:

1. Minimum may be suitable when adjacent to landscaped private property
2. Most applicable to scenarios with street fronting Commercial Development
3. On Rural cross-section total shoulder from edge of lane shall be 2.40m

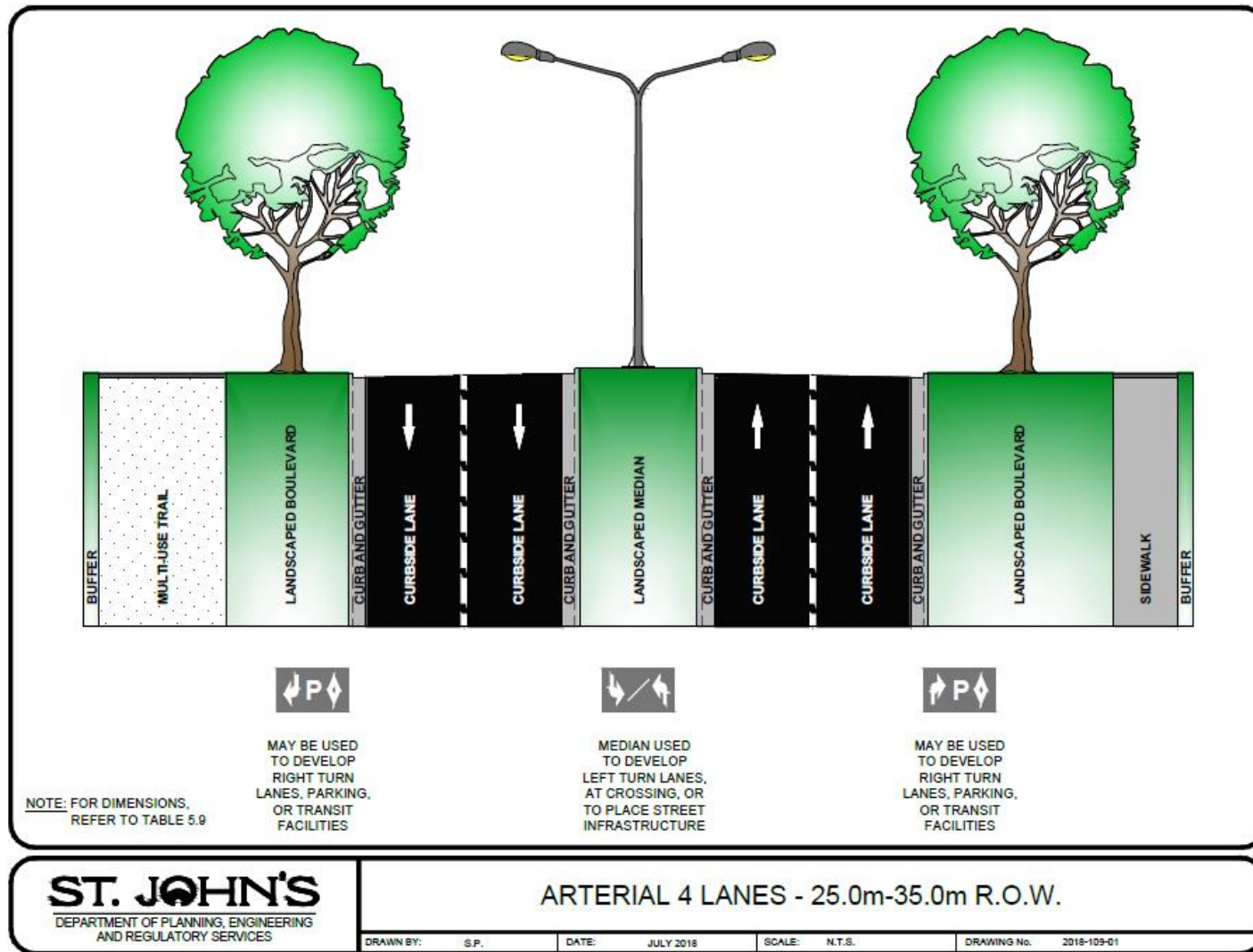

Figure 5-2 - Arterial 4 Lanes Cross-Section Elements (25.0m to 35.0 R.O.W.)

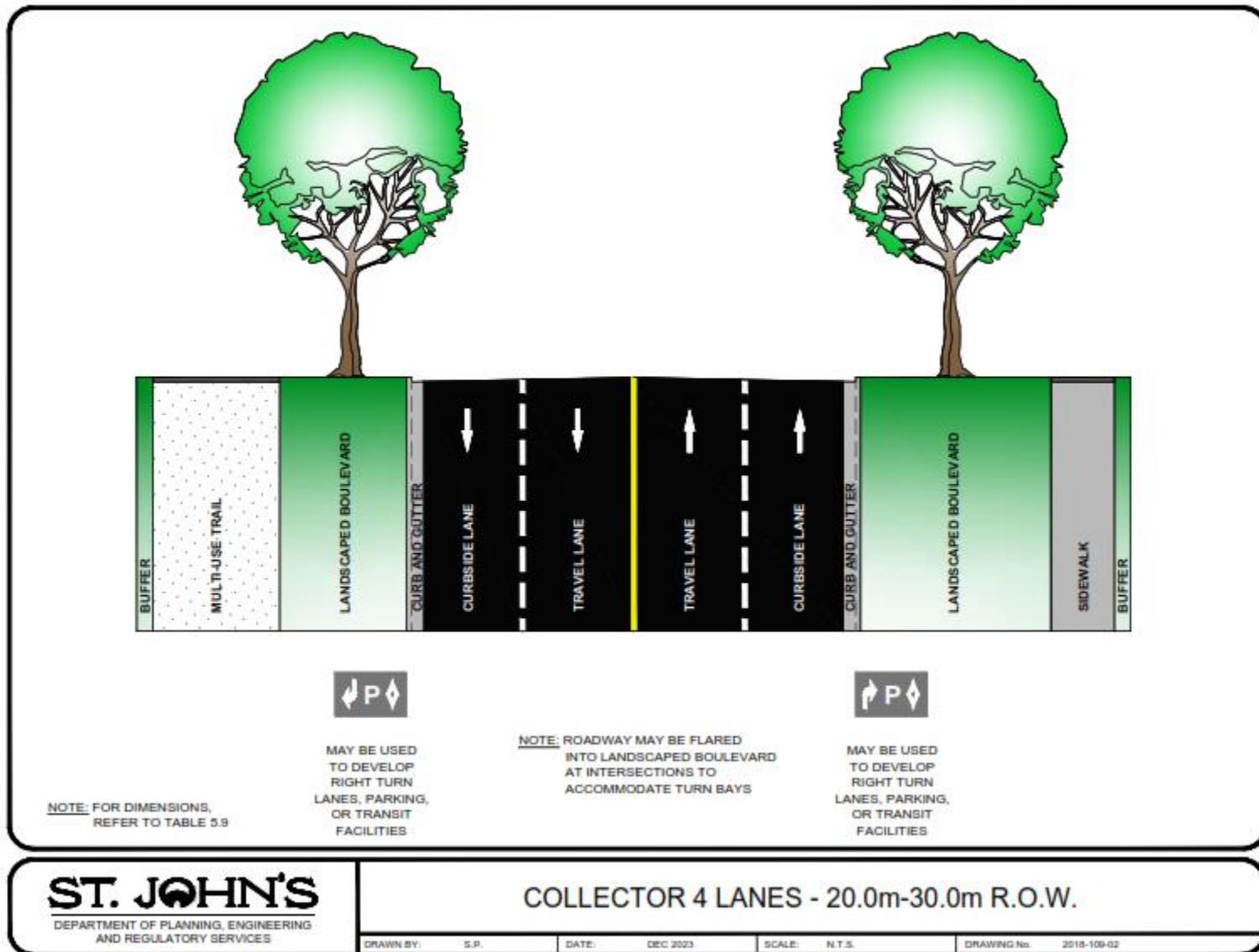

Figure 5-3 - Collector 4 Lanes Cross-Section Elements (20.0m - 30.0m R.O.W.)

ST. JOHN'S
DEPARTMENT OF PLANNING, ENGINEERING
AND REGULATORY SERVICES

COLLECTOR 4 LANES - 20.0m-30.0m R.O.W.

DRAWN BY: S.P. DATE: DEC 2023 SCALE: N.T.S. DRAWING No. 2018-109-02

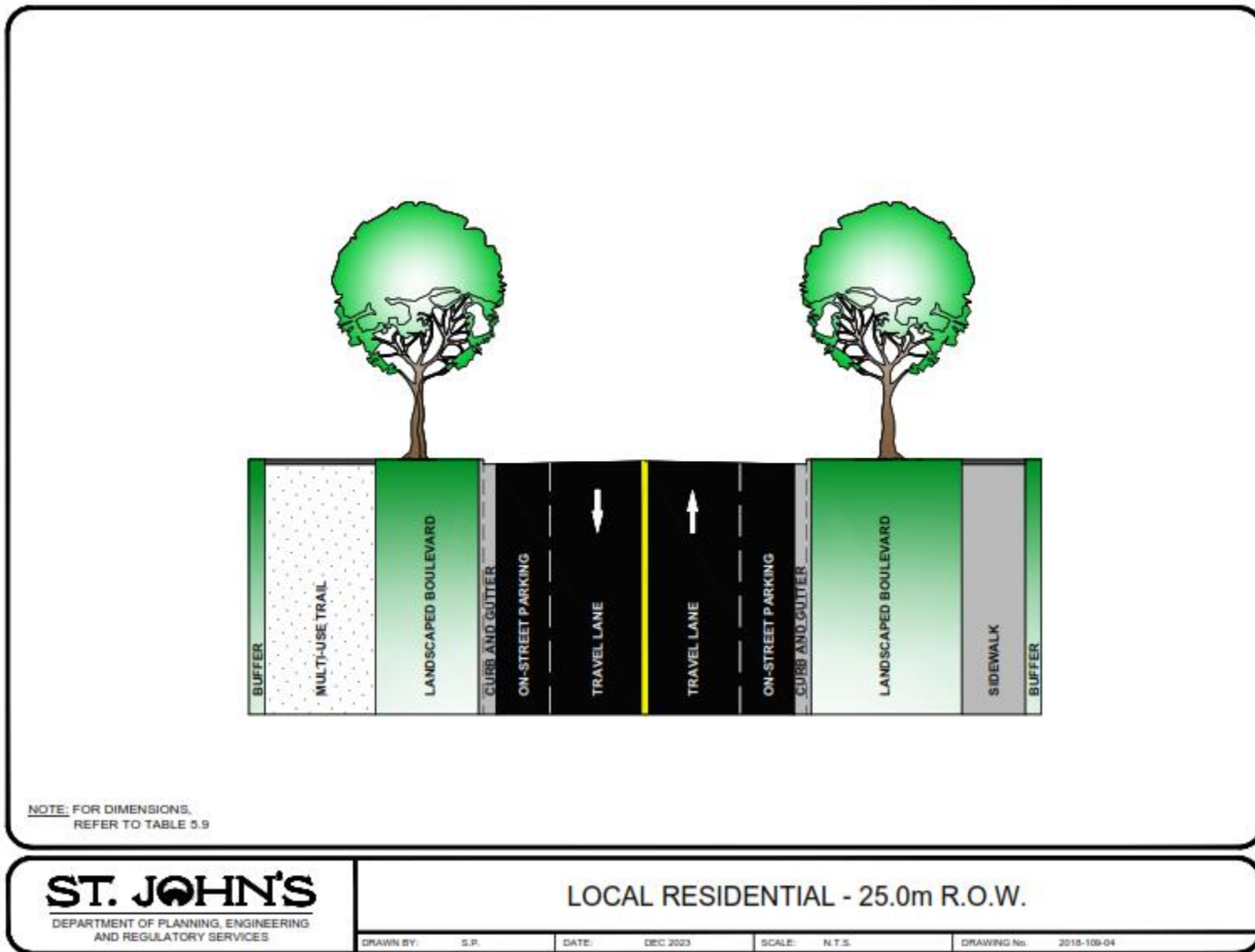

Figure 5-4 - Local Residential Cross-Section Elements (25.0m R.O.W.)

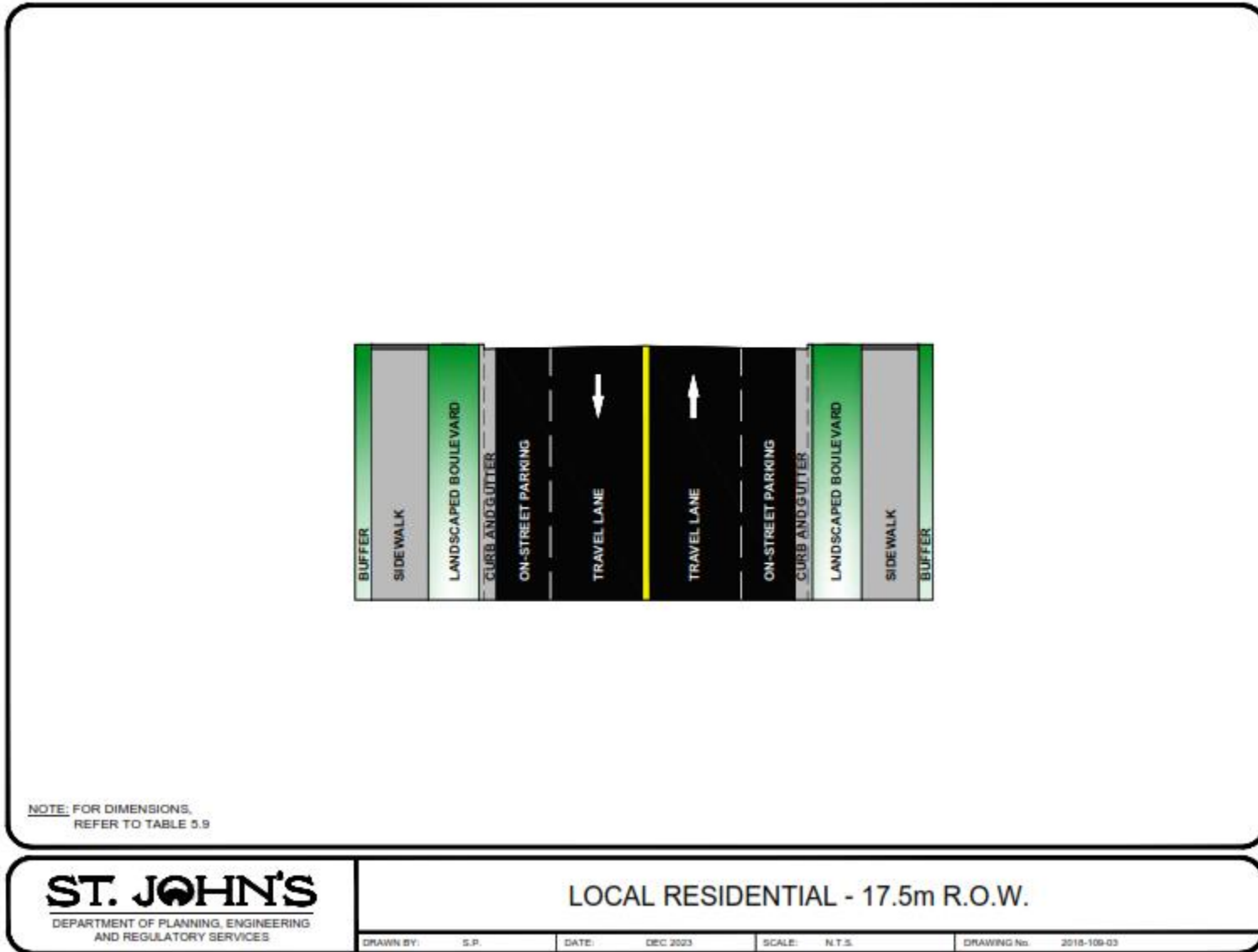

Figure 5-5 - Local Cross-Section Elements (17.5m R.O.W.)

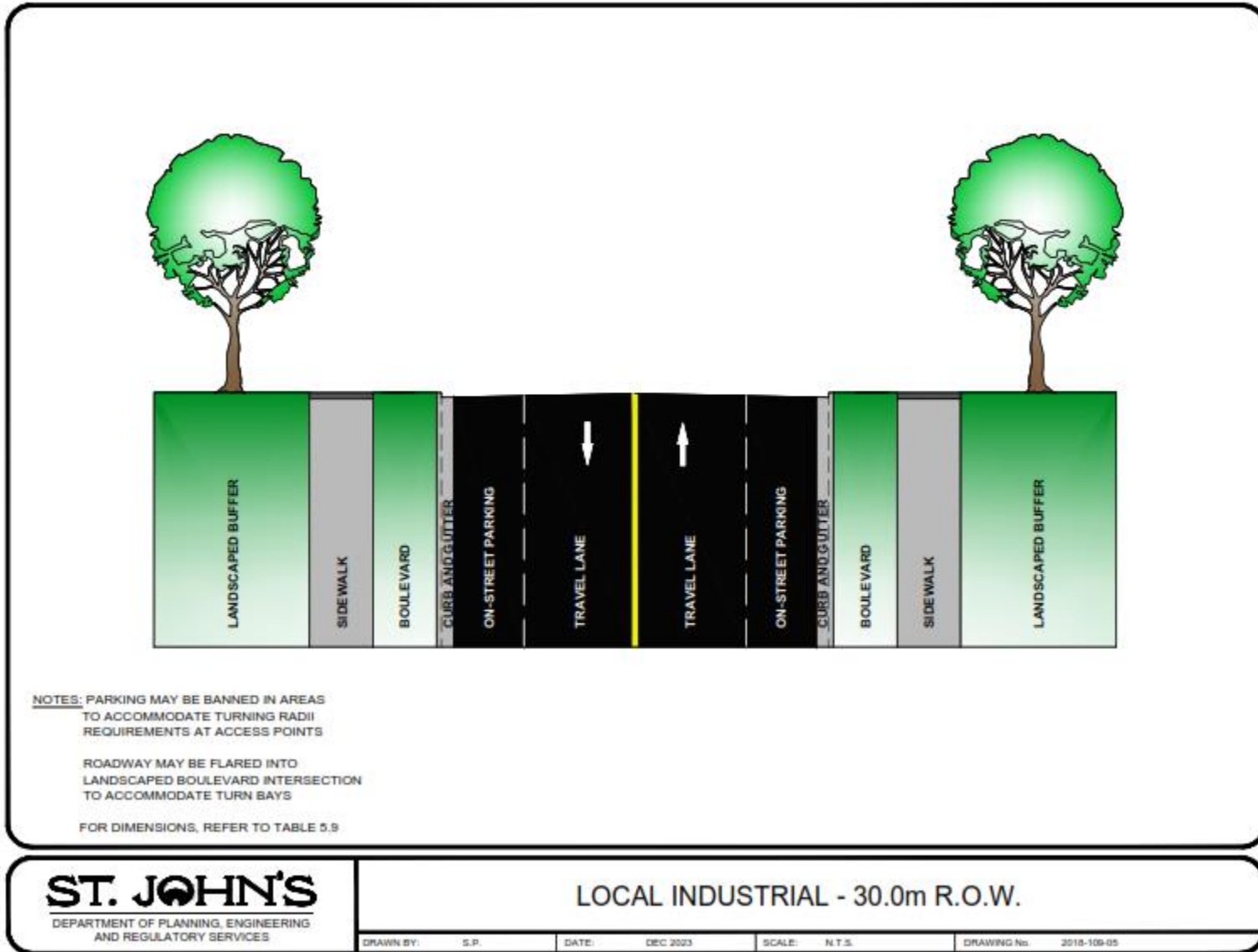

Figure 5-6 - Local Industrial Cross-Section Elements (30.0m R.O.W.)

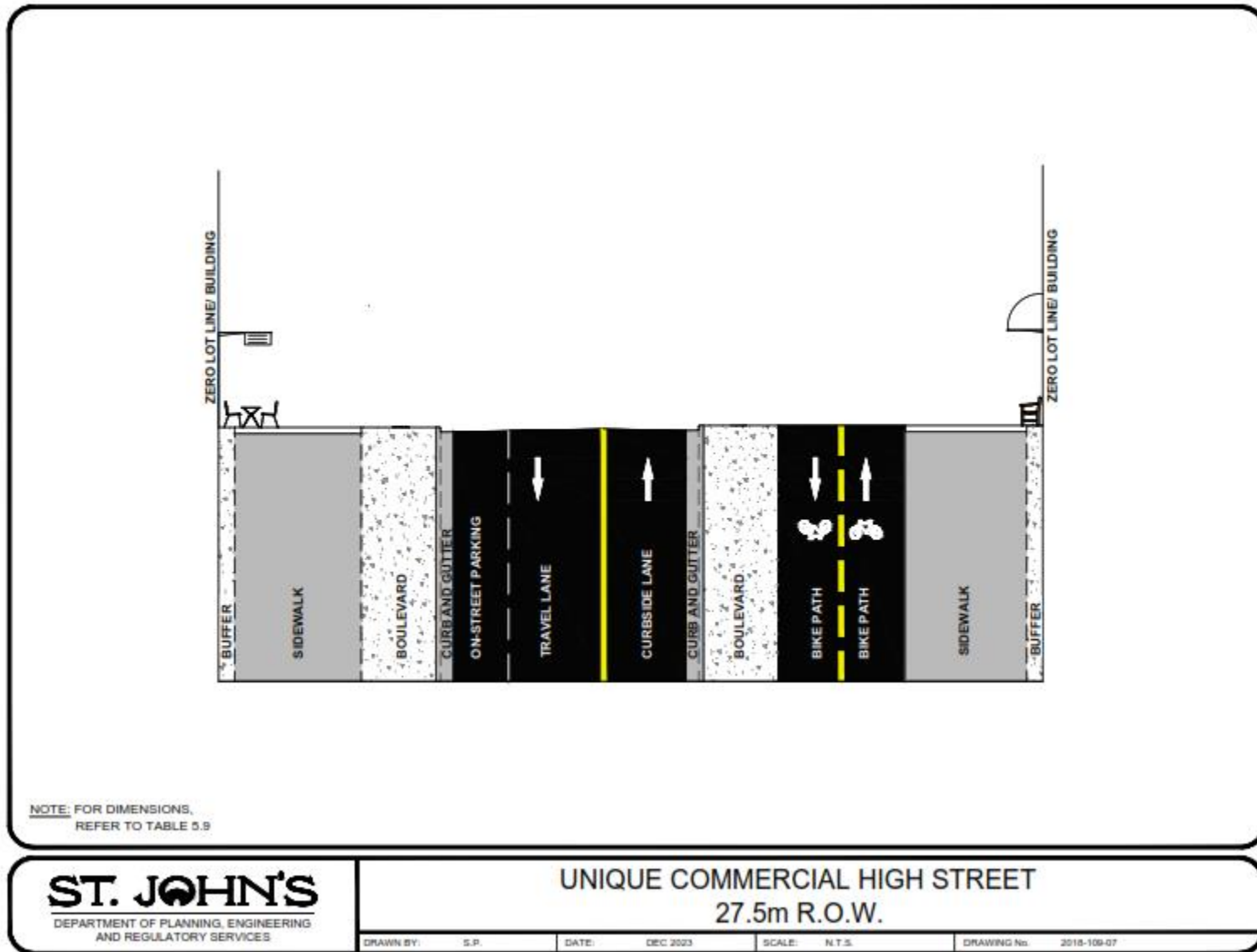

Figure 5-7 - Unique Commercial High Street Cross-Section Elements (17.5m R.O.W.)

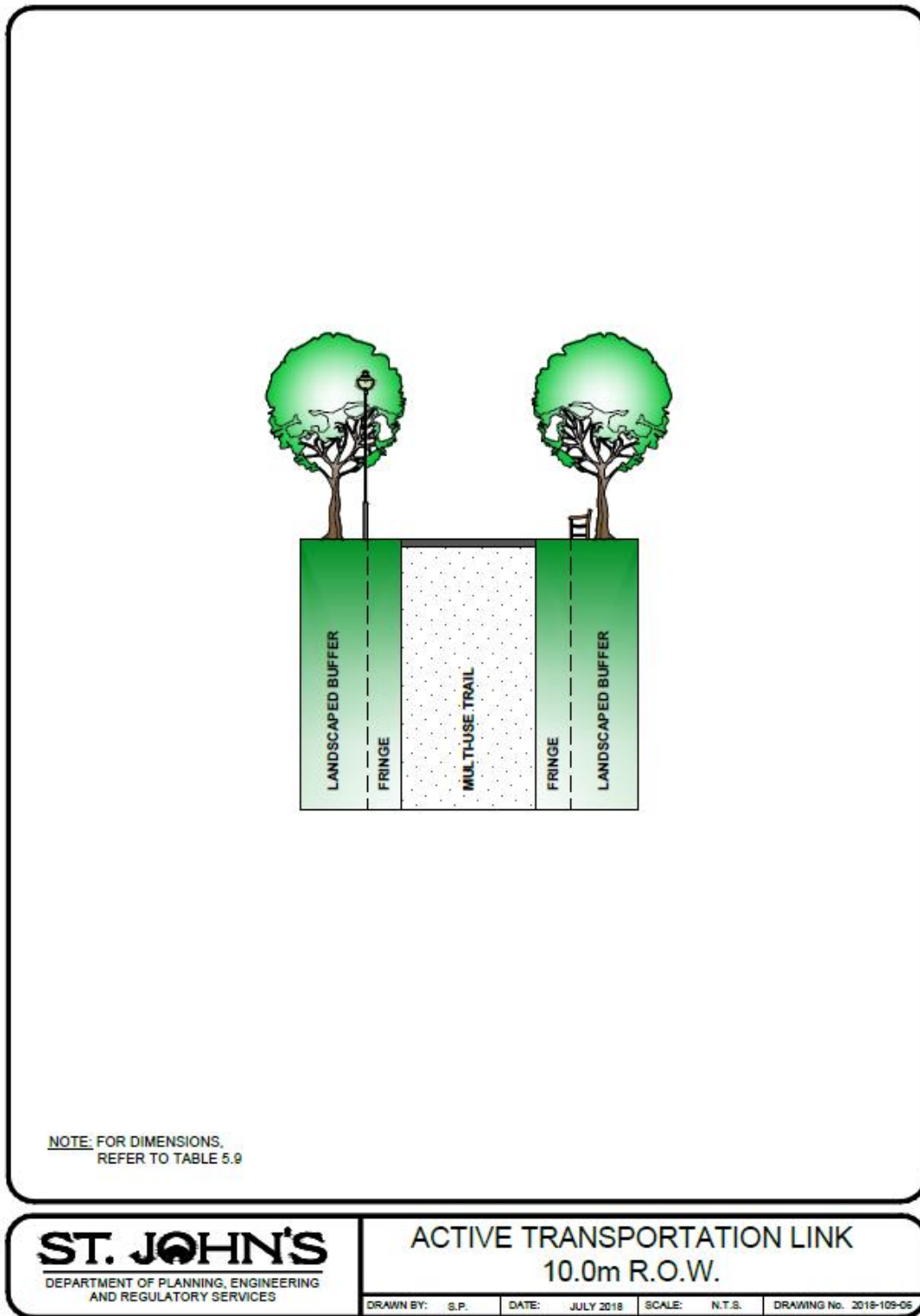

Figure 5-8 - Shared-Use-Path (Multi-Use Trail) Cross-Section Elements (10.0m R.O.W.)

5.6 GENERAL SIGHT DISTANCE REQUIREMENTS

5.6.1 GENERAL

At all times the stopping sight distances must be unobstructed to ensure safe operation of the City's streets and access points. Stopping sight distances vary based on the roadway speed and grade and may be found in the most recent edition of the TAC Geometric Design Guide for Canadian Roads:

- Table 2.5.2 on level roadways (2017 edition)
- Table 2.5.3 on graded roadways (2017 edition)

5.6.2 CORNER TRIANGLE

As referenced in the City of St. John's Development Regulations, Section 7.2.3, the corner triangle must remain clear of any and all sight obstructions. As such the area located within the corner triangle has the following restrictions:

- I. No structures are to be in the area;
- II. No signs are to be in the area;
- III. No parking is to be in the area;
- IV. No access points are to be in the area;
- V. Any vegetation is to have a height no greater than 0.75 meters from the grade of the street; and
- VI. Any trees encroaching into the corner triangle are to have all branches removed to a minimum height of 2.5 meters from the grade of the street.

Design exceptions may be granted or required based on area context.

5.7 ACCESS MANAGEMENT

5.7.1 BY-LAW

The City's Access Control By-Law grants the City the authority to restrict, relocate, or redesign any access onto a public street. However, each property must be afforded at least one access to a public street. Access to adjacent parcels may be provided by a shared or mutual access arrangement.

5.7.2 COMMERCIAL ACCESS

Any Commercial access onto a public street must be designed to ensure that vehicles may enter and exit the roadway without negative impacts or safety concerns. The minimum sight distance requirements should be met so that people can see approaching vehicles, people walking and wheeling, and people cycling from the access exit point, as per TAC Geometric Design Guide for Canadian Roads. Any signage must be installed outside the public Right-Of-Way.

The design of the access, including width and radius, will be based on the design vehicle. In general, an access shall be a minimum of 6 meters in width for two-way accesses.

The sidewalk shall be continuous along the property. Where a continuous sidewalk elevation cannot be maintained, access design shall include Commercial low back curb and sidewalk as per City of St. John’s Specification Book. Any required ramps in sidewalk to accommodate access will be placed based on the leading edge of radius required to accommodate design vehicle as shown in Figure 5-9.

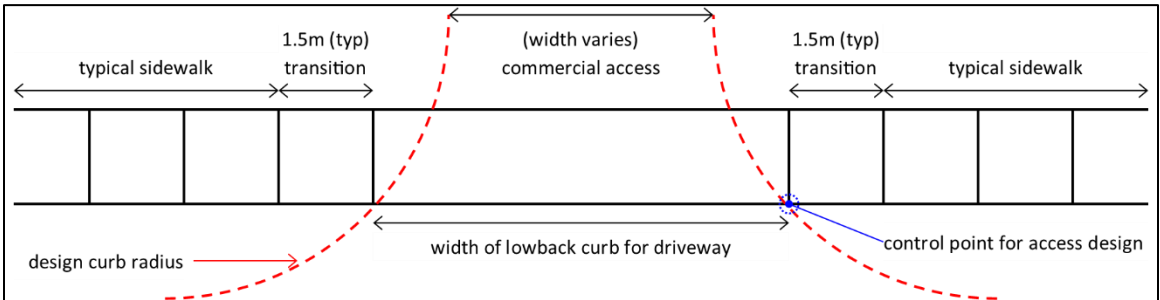

Figure 5-9- Sidewalk Ramps

Where a shared-use path crosses a Commercial access, the crossing shall be constructed of reinforced concrete. The shared-use path shall be of continuous elevation along the property. If a design exception is approved in situations where a continuous elevation cannot be maintained, access design shall include Commercial low back curb and concrete shared-use path through the crossing as per the City of St. John’s Specification Book. Any required ramps in shared-use path to accommodate access will be placed based on the leading edge radius required to accommodate design vehicle, similar to Figure 5-9.

The access shall provide clear passage for a design vehicle to enter the site. Adequate on-site vehicle circulation must be provided such that a design vehicle can enter the site without stopping and turn around on site without reversing out of a Commercial access onto a public roadway.

The access shall be located such that there are no conflicts with existing or other planned access points along the roadway. Such conditions would include:

- I. Access shall be located directly opposite or, if acceptable to the City, with a positive offset to opposing access points on the opposite side of the roadway to avoid staggered intersection situation.
- II. Left turn storage into an access must be provided within the street right of way if warranted. If a left turn bay must be constructed, the Developer will do so before left turns are permitted. If a storage lane/bay cannot be accommodated due to existing conditions, left turns will be prohibited and the access must be designed to eliminate left turns into the property.

5.7.3 DESIGNATED LIMITED-ACCESS STREETS

An individual driveway or access shall only be permitted to enter directly onto a designated limited-access street under exceptional circumstances.

The following streets are designated as limited-access streets:

- Allandale Road
- Blackmarsh Road
(west of Hamlyn Road)
- Captain Whelan Drive
- Columbus Drive / Prince Phillip Drive
- East White Hills Road
- Freshwater Road
(west of Empire Avenue)
- Harbour Drive
- Kenmount Road
- Kenna's Hill
- Logy Bay Road
- MacDonald Drive
(west of Torbay Road)
- New Gower Street
- Portugal Cove Road
(north of New Cove Road)
- Southlands Boulevard / Danny Drive
- Thorburn Road
(Goldstone Street to Freshwater Road)
- Topsail Road
- Torbay Road
- Water Street (west of Waldegrave Street)

The presence of existing driveways or access points to a designated limited-access street does not indicate that additional access will be granted.

Existing driveways or access points along designated limited-access streets shall be eliminated where possible. This includes elimination by providing site access through an adjacent public street or requiring mutual access arrangements between adjacent properties.

5.7.4 DRIVEWAY DESIGN AND ACCESS

All Residential driveways shall have a minimum depth of 6 meters from the property line and minimum width of 3.0 meters. This portion of the driveway shall typically be aligned

at 90° to the street line with a typical slope between 2% and 10% and graded towards the street. Exceptions may be considered at the City's discretion.

Adequate on-site vehicle circulation must be provided for any site served by a parking lot or parking garage such that a design vehicle can turn around on site with no reversing out of the driveway access onto a public roadway. Parking lot surfaces shall have a typical slope of $\leq 5\%$. The City of St. John's Development Regulations outline required separation from property lot lines.

At a "T" intersection, a Residential driveway shall not be located such that it falls inside an area created by projecting the edge of the street right of way of the stem of the "T" across the intersecting street.

No driveway access is permitted within the corner triangle created by the intersection of two public streets (see Section 7.2.3 of the City of St. John's Development Regulations).

When an asphalt shared-use path crosses a Residential driveway, driveway ramps located within landscaped boulevards shall be concrete, as per the City of St. John's Specification Book.

5.7.5 SELECTION OF DRIVEWAYS OR PARKING LOTS

For Residential Developments with 5 or more units on a single lot, a parking lot is required. A parking lot may be required in other instances to provide for the parking needs of the Development. The factors below will be included in the evaluation that determines whether driveways are permitted or if a parking lot will be required.

Table 5-10 summarizes factors and results that describe the requirements for a driveway and/or a parking lot.

Table 5-10 - Factors and Results for Driveways and Parking Lot Selection

Factor	Result
For Residential Development, can the lot meet the requirements in Section 7.6 of the City of St. John's Development Regulations?	If driveway width or frontage used exceed thresholds, then a parking lot is required.
Is it possible to provide driveways and still meet the snow storage requirements outlined in Division 11 – Winter Design?	If snow storage cannot be met, then a parking lot is required.
Does the adjacent street have more than 2 lanes, carry higher traffic volumes (>1000 vph), and/or have higher traffic speeds (>50 kph)?	Wider, higher volume, and/or higher speed streets are more likely to require a parking lot.
Are driveways of the density contemplated common in the immediate area?	Good fit with local context favours uses of driveways.
Are individual driveways a good fit with the long-term Development of the immediate area and the long-term function of the adjacent street?	Good fit with long-term context favours uses of driveways.
Are there specific safety concerns such as proximity to an intersection or sightlines with some, or all, of the proposed driveway locations?	Presence of safety concerns to driveways favours use of a parking lot.
For Residential Development, does the building have a single common access to multiple units?	Common parking lots are generally more suitable for buildings with common access.
Are there 6 or more parking spaces required?	The more spaces required the more likely a parking lot is required.

5.8 SITE DESIGN

5.8.1 EXTERIOR PATHS OF TRAVEL

An accessible path of travel must be provided from the public sidewalk to entrances and exits. All Commercial buildings and multi-family Residential buildings will be required to provide this path.

5.8.2 PARKING LOTS

A Commercial property must be designed to accommodate the turning movements of all vehicle types, associated with the operations, within the site. Vehicles will not be permitted to back from the street Right-Of-Way into the site or from the site out onto the street Right-Of-Way. Sites must be designed such that the need for vehicle reversing is limited to a simple 3-point maneuver for a typical passenger vehicle.

All parking must be located a minimum of 6 meters from the street line. The location of parking will be measured at the edge of the parking surface. Where a curb is provided, the face of this curb will serve as the edge of the parking surface. The requirements

identified in Table 5-11 and Figure 5-10 must be met for all parking stall dimensions and aisle widths.

Table 5-11 - Parking Table (Exterior Parking Lots)

A	B	C	D	E	F	G
0°	2.74	2.74	3.66	7.01	9.14	-
20°	2.74	4.57	3.35	8.02	12.50	9.91
30°	2.74	5.27	3.35	5.49	12.90	11.52
45°	2.74	6.04	3.96	3.87	16.00	14.17
60°	2.74	6.40	5.49	3.17	18.29	16.92
70°	2.74	6.40	7.32	2.93	18.59	17.65
80°	2.74	6.19	7.32	2.77	19.60	19.11
90°	2.74	5.79	7.32	2.74	18.90	-

Indoor parking stall dimensions may be reduced to B=2.6m, and for 90° stall layout, C=5.6m, D=6.7m, F=18m

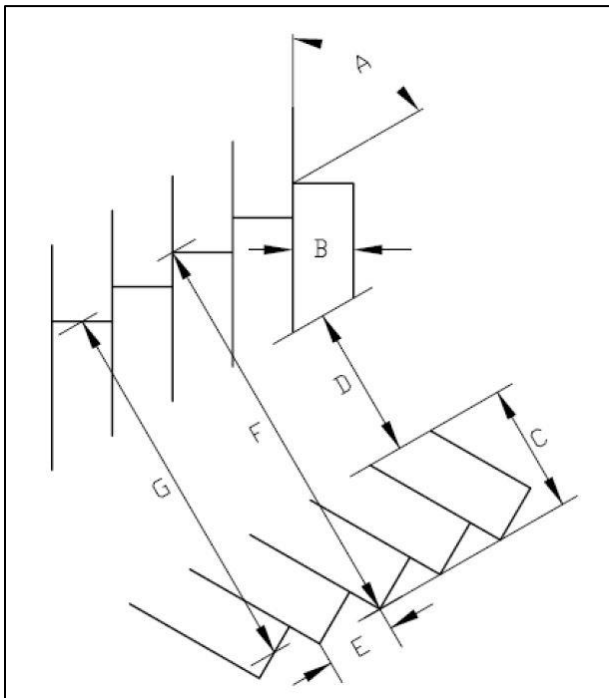

Figure 5-10 - Parking Stall Geometry

Where A to G dimensions in

Table 5-11 and depicted in Figure 5-10 are defined as follows:

- A = parking angle in degrees
- B = stall width in meters
- C = stall depth in meters
- D = aisle width in meters
- E = curb length per car in meters

F = center to center width in meters

G = curb to curb distance in meters from stall center

5.8.3 ACCESSIBLE PARKING

Off-street accessible parking shall be in conformance with Figure 5-11. If the Provincial Regulations shown in this figure are updated, the Provincial regulations shall govern.

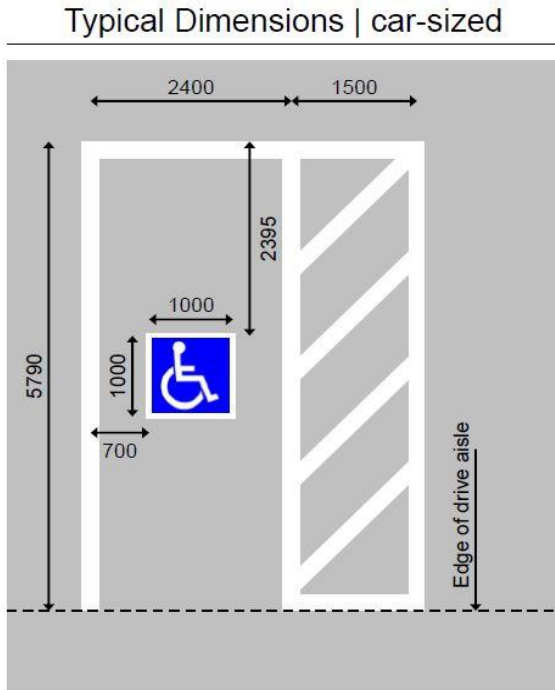

Off-street Accessible Parking

Buildings Accessibility Regulations
<http://www.assembly.nl.ca/Legislation/sr/Regulations/rc961140.htm>

Regulations

Parking

8. (1) In a parking area provided for a building there shall be at least one accessible parking space or 6% of the total number of parking spaces, whichever is greater, designed and designated for use by persons with disabilities.

(2) In each parking area at least one in every 6 accessible parking spaces shall be a van-sized accessible parking space.

(3) Where a parking area only has one accessible parking space it shall be a van-sized accessible parking space.

Schedule

Parking spaces

14. (1) Parking spaces designated for persons with disabilities

(a) that service a specific building shall be located on the shortest possible accessible route to the principal entrances of the building;

(b) in separate parking structures or lots that do not serve a particular building shall be located on the shortest possible circulation route to an accessible pedestrian entrance of the parking facility;

(c) may have 2 accessible parking spaces sharing a common aisle and colour; and

(d) shall have the access aisle marked as a "no parking" area and meet the criteria for an exterior path of travel.

(2) A car-sized accessible parking space shall

(a) be at least 2400 millimetres wide; and

(b) have an adjacent access aisle that is at least 1500 millimetres wide adjacent and parallel to the parking space.

(3) A van-sized accessible parking space shall

(a) be at least 2600 millimetres wide;

(b) have an adjacent side access aisle at least 2000 millimetres wide; and

(c) have an adjacent rear access aisle at least 2000 millimetres long.

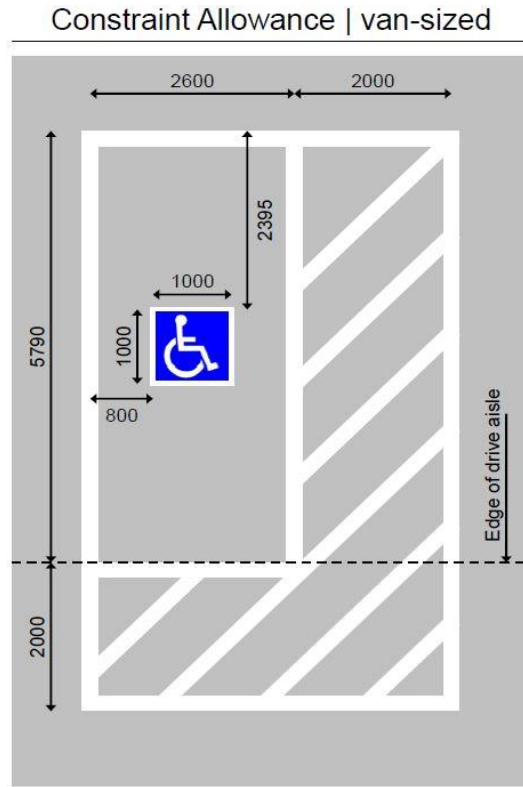
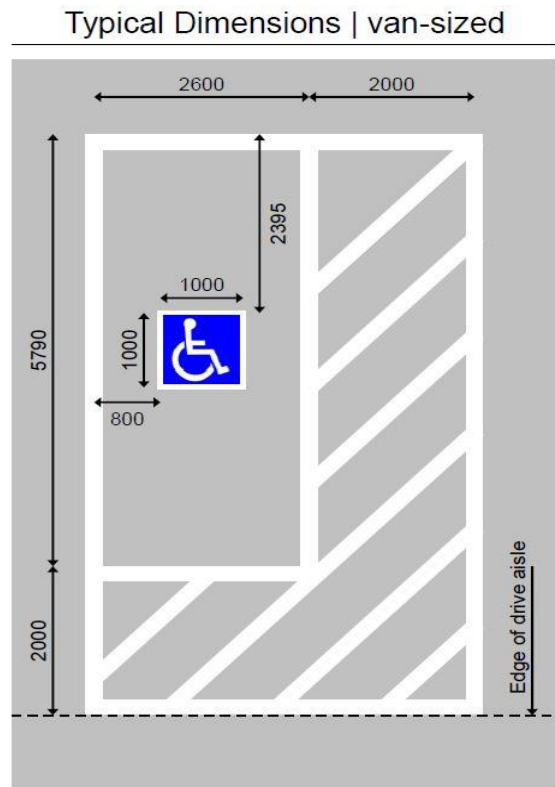

Figure 5-11 - Off-Street Accessible Parking Dimensions and Layout

5.8.4 VISITOR PARKING

Where visitor parking is provided, for example at an apartment building development, the spaces provided shall be readily available to the primary building entrance for each building served and be clearly identified as visitor parking.

5.8.5 BICYCLE PARKING

Bike parking is required at:

- Multifamily Residential buildings;
- Schools/University campuses;
- Commercial businesses;
- Business offices;
- Parks, sidewalks, and other municipal amenities;
- Public transit stations, pick-ups/drop-offs;
- Hospitals;
- Car parking lots and garages; and
- Other public spaces intended for usage by the community.

Where bicycle parking is provided the spaces shall be:

- Readily available to the primary building entrance;
- Sheltered from weather; and
- On a hard surface.

If provided, interior parking shall be considered to meet these requirements.

A minimum of 2 bicycle parking spaces must be exterior for any apartment building or office use. A single 'ring and post' or 'inverted u' bicycle rack, if sited properly, provides 2 bicycle parking spaces.

Bike racks must meet the following criteria:

- Supportive: provides at least two points of contact with the bicycle frame. Bike racks should be minimum 80 cm tall and 45 cm wide.
- Lockable: allows the frame and at least one wheel to be securely locked to the rack with a U-lock
- Flexible: accommodates a variety of bicycle types and attachments by providing clearances and avoiding rack designs that limit the length, height or width of bicycles or attachments.
- Intuitive: bike racks must be recognizable and simple to use. User should not have to lift the bicycle or move another bike to use the rack.
- Secure & durable: must be installed on a concrete surface and made of a durable and secure material

Inverted U (also called loop or staple racks) and Ring & Post style bicycle racks meet these criteria and are generally appropriate for all applications.

For more details, including quantity requirements, refer to Section 8.14 of City of St. John's Development Regulations.

5.9 CANADA POST SUPER MAILBOX SITES

5.9.1 APPROVALS

A copy of the Subdivision Plan indicating the location of Canada Post Super Mailbox sites shall be submitted to both the City of St. John's and Canada Post for approval. A copy of the Canada Post approval shall be submitted to the City.

5.9.2 GENERAL LOCATION CRITERIA OF CITY

Where possible, the Super Mailbox sites shall meet the following criteria:

- I. Super Mailbox sites shall be located on the flanking side of corner lots;
- II. Super Mailbox sites can be located adjacent to Open Spaces, pathways or parks, but shall not impede access by City maintenance vehicles;
- III. Super Mailbox sites shall be located on the predominantly homecoming side of the street to ensure that most users can retrieve their mail without crossing the street;
- IV. Super Mailbox sites shall not be located along street frontage where parking restrictions apply unless a short-term parking layby is provided;
- V. Super Mailbox sites shall not be located closer than 10m from a fire hydrant or transit stop;
- VI. Super Mailbox sites shall not be located in close proximity to utility poles or street lighting standards;
- VII. Super Mailbox sites shall be located in such a manner that they do not constitute sight distance restriction to either pedestrians or motorists;
- VIII. Super Mailboxes must be setback a minimum of 4.0m from the curb face to ensure acceptable sight distance is available to adjacent properties;
- IX. Super Mailboxes shall be located a minimum of 15m from any crosswalk on the approach side;
- X. Super Mailboxes shall be located a minimum of 20-25 meters from any unsignalized intersection;

- XI. Super Mailboxes shall be located a minimum of 100m from a signalized intersection;
- XII. Super Mailboxes shall be located on Local streets, however where an installation is required/proposed for a street classified above a Local status, the location must provide a lay-by for vehicle storage unless sufficient space and roadway width is currently available to accommodate stopped vehicles without interfering with established driving and parking lanes;
- XIII. Super Mailboxes shall avoid being installed along the inside of a turn most notably in areas with tight roadway curvatures such as the 50m design radius for a Local street; and
- XIV. A curb ramp shall be provided at Super Mailbox locations. This ramp does not require the standard tactile plates.

5.10 POWER POLES AND TRANSMISSION INFRASTRUCTURE

5.10.1 GENERAL REQUIREMENTS

All Newfoundland Power infrastructure shall be placed along the public street Right-Of-Way in a manner such that no sight obstructions or safety concerns are created. In general, the following conditions shall be met:

- I. All infrastructure such as poles and street lights are installed behind the sidewalk and do not impede pedestrian usage. Where a boulevard is provided poles may be placed within it.
- II. For new Residential Developments, the City requires underground servicing unless, in the sole discretion of the City, it makes sense not to do so.
- III. For new Developments, a plan is submitted which includes all access points and pole locations to ensure there are no overlaps or encroachment issues.
- IV. Poles are not to be installed in traffic islands. Poles shall not be placed such that they obstruct street or roadway information signage.

5.11 SIGNS

Traffic signs are tools for warning and guiding people using the transportation network. Traffic signs help regulate the traffic flow among people walking and wheeling, cycling, driving and using City streets and highways. Traffic signs or road signs are signs erected at the side of or above roads giving instructions or providing information to road users to ensure road safety and guidance.

5.11.1 REGULATORY AND TRAFFIC CONTROL SIGNS

All regulatory, warning, and traffic control signs located along public locations, and street Right-Of-Way and Commercial developments must follow the most recent edition of the TAC Manual of Uniform Traffic Control Devices for Canada guidelines.

5.11.2 OTHER SIGNS

Signs located along a public street right of way must meet the requirements of the St. John's Sign By-Law. Sign content, form, placement, and installation must be consistent and provide clear messaging to users of the transportation network.

5.12 ROAD STRUCTURE DESIGN

5.12.1 GENERAL

This Section presents the guidelines for the design of flexible pavements to meet the required design life, traffic loading, subgrade strength, and environmental factors. Prior to construction, a Road Structure Design shall be submitted, under cover letter, by the Developer or their Consulting Engineer to PERS for approval.

5.12.2 ROAD CLASSIFICATIONS

All roadway sections within The City of St. John's limits, for the purpose of road structure design, are classified as follows:

- I. Arterial Streets
- II. Collector Streets
- III. Local Streets
- IV. Unique Streets
- V. Active Transportation Links

5.12.3 DESIGN METHODOLOGY

AASHTO pavement design methodology (1993) shall be used for new construction of all City Streets.

The design pavement structure for the governing lane shall be applied to adjacent lanes.

5.12.4 PAVEMENT DESIGN

Traffic Inputs

Pavement designs shall be based on the AASHTO Guide for Design of Pavement Structures (1993). Design shall be based on the predicted traffic loading in terms of Equivalent Single Axle Loadings (ESALs), based on the Average Annual Daily Traffic (AADT), heavy vehicle percentage and load equivalency truck factor based on the following assumptions:

- I. Annual Average Daily Traffic (AADT):
 - a) Arterial Major Street – 50,000
 - b) Arterial Minor Street – 30,000
 - c) Collector Street – 20,000
 - d) Local Street – 5,000
 - e) Unique Street – As per role in network

- II. Percent Heavy Vehicles:
 - a) Arterial – 5%
 - b) Collector – 3%
 - c) Local – 1%
 - d) Unique Street – As per role in network

- III. The Load Equivalency Truck Factor used shall be 1.7.

- IV. The following traffic inputs shall be used as default in the traffic analysis:
 - a) Directional Distribution: 50% in each direction.
 - b) Growth Rate: 1%.
 - c) Lane Distribution factor: 1 for one lane per direction, 0.8 for two lanes per direction.

- V. Reliability and analysis period shall be as per Table 5-12.

Table 5-12 - Reliability and Analysis Period

Class	Reliability	Analysis Period
Arterial Major	95	40
Arterial Minor	90	30
Collector	85	25
Local	70	20
Unique Streets	As per role in network	As per role in network

Revisions to the default traffic data inputs above may be used if justified by project specific traffic information or otherwise determined by the City to meet a particular demand.

Using the traffic inputs, the Design ESALs (in terms of 80 KN single axle loads) shall be determined in accordance with the following equations:

$$\text{ESALs/day/direction} = \text{AADT}/2 * (\% \text{ Heavy Vehicles}/100) * \text{Load Equivalency Truck Factor} * \text{Lane Distribution Factor}$$

$$\text{Yearly ESALs} = \text{ESALs/day/direction} \times 365 \times (1 + g)^{i-1}$$

Where:

g = Growth Rate/100

i = Specific Year of Analysis

This formula calculates the number of ESALs each year. To determine the number of ESALs over the entire life of the pavement use the above formula for every year of the analysis period and sum the values. That is:

$$\text{Design ESALs} = \sum_{i=1}^n \text{ESALs/day/direction} \times 365 \times (1 + g)^{i-1}$$

Where:

n = Analysis Period (years)

Example 5.12.1

A new street has been proposed. The street has been classified as a local street with one lane in each direction. Determine the Design ESALs for the road structure.

$$\text{ESALs/day/direction} = \text{AADT}/2 * (\% \text{ Heavy Vehicles}/100) * \text{Load Equivalency Truck Factor} * \text{Lane Distribution Factor}$$

For a local street with one lane per direction:

AADT = 5000

Percent Heavy Vehicles = 1%

Load Equivalency Truck Factor = 1.7

Lane Distribution Factor = 1

Growth Rate = 1%

Analysis Period = 20 years

$$\text{ESALs/day/direction} = 5000/2 * (1/100) * 1.7 * 1 = 42.5 \text{ ESALs}$$

Yearly ESALs are determined using the following equation:

$$\text{Yearly ESALs} = \text{ESALs/direction/day} \times 365 \times (1 + g)^{i-1}$$

$$\text{For year 1: Yearly ESALs} = 42.5 \times 365 \times (1 + 0.01)^{1-1} = 15512.5 \text{ ESALs}$$

$$\text{For year 15: Yearly ESALs} = 42.5 \times 365 \times (1 + 0.01)^{15-1} = 17831.2 \text{ ESALs}$$

Design ESALs are determined by summing the yearly ESALs for each year of the analysis period. That is:

$$\text{Design ESALs} = \sum_{i=1}^n \frac{\text{ESALs}}{\text{day}} \times \text{direction} \times 365 \times (1 + g)^{i-1}$$

Table 5-13 - Design ESALs per year

Year	ESALs
1	15,513
2	15,668
3	15,824
4	15,983
5	16,142
6	16,304
7	16,467
8	16,631
9	16,798
10	16,966
11	17,135
12	17,307
13	17,480
14	17,655
15	17,831
16	18,010
17	18,190
18	18,372
19	18,555
20	18,741
Design ESALs (Total)	341,570

Example 5.12.2

A new street has been proposed. The street has been classified as an Arterial Minor Street with two lanes per direction. Determine the Design ESALs.

For an Arterial Minor Street with two lanes in each direction:

AADT = 30,000

Percent Heavy Vehicles = 5%

Load Equivalency Truck Factor = 1.7

Lane Distribution Factor = 0.8

Growth Rate = 1%

Analysis Period = 30 years

$$\text{ESALs/day/direction} = 30000/2 * (5/100) * 1.7 * 0.8 = 1020 \text{ ESALs}$$

Table 5-14 - Design ESALs per Year

Year	ESALs
1	372,300
2	376,023
3	379,783
4	383,581
5	387,417
6	391,291
7	395,204
8	399,156
9	403,148
10	407,179
11	411,251
12	415,363
13	419,517
14	423,712
15	427,949
16	432,229
17	436,551
18	440,917
19	445,326
20	449,779
21	454,277
22	458,820
23	463,408
24	468,042
25	472,722
26	477,449
27	482,224
28	487,046
29	491,917
30	496,836
Design ESALs (Total)	12,950,415

Subgrade Support Characterization

Minimum design shall be based on the actual Resilient Modulus (M_R) of the representative soils.

Subgrade locations shall be selected by qualified personnel from a testing agency to confirm that they are representative of site conditions and tested according to applicable Standards. A minimum of two (2) tests is required for every 4000 m² of subgrade type and the M_R shall be based on the least of the undertaken tests.

A summary of all laboratory test results including assumptions, and/or calculations made in the assessment of the subgrade support in addition to the soil classification (as per Unified Soil Classification System) must be included in the road structure design.

Subgrades less than 35 MPa requires subgrade improvement prior to construction of the road structure.

Geogrids for soil stabilization will not be accepted for construction of new streets unless the geogrid is required for lateral restraint in areas where there are roadside ditches and rutting may be a concern. Geogrids may be considered for temporary streets if applicable.

Design Inputs

The following shall be considered as the design inputs for the flexible pavement design to determine the required structural number:

- I. The Design ESALs are calculated as per above.
 - II. The Initial Serviceability, Terminal Serviceability, and Serviceability Loss shall be 4.2, 2.5, and 1.7, respectively.
 - III. The Overall Standard Deviation of 0.45.
 - IV. Subgrade Resilient Modulus (M_R) value determined as per above.
 - V. Design Layer Coefficients to be used as follows:
 - Surface/Base Course Asphalt = 0.44
 - Class "A" = 0.13
 - Class "B" = 0.10
- For new construction, the design Drainage Coefficients used for Base or Sub-base layers shall be 1.0.

The design Structure Number shall be equal to or greater than the required Structural Number.

For pavement widening, the total design pavement structure thickness shall be equal to or greater than the adjacent pavement, to allow for positive drainage.

Pavement cross-section thickness by type of roads is illustrated in Table 5-15.

Table 5-15 - Minimum Pavement Sections

Road Classification	Asphalt Thickness (mm) – Base/Base/Surface	Granular Base Class “A” – (mm) Minimum	Granular Sub-Base Class “B” – (mm) Minimum
Arterial (Major)	50/50/50	200 <i>(Actual to be based on Geotech Report and Design)</i>	500 <i>(Actual to be based on Geotech Report and Design)</i>
Arterial (Minor)	50/50/50	200 <i>(Actual to be based on Geotech Report and Design)</i>	300 <i>(Actual to be based on Geotech Report and Design)</i>
Collector	40/40/50	150 <i>(Actual to be based on Geotech Report and Design)</i>	250 <i>(Actual to be based on Geotech Report and Design)</i>
Local	0/50/50	100	200
Unique Streets	Based on role in network	Based on role in network	Based on role in network
Active Transportation Links	0/50/50	150 on top of non-woven geotextile <i>(Actual to be based on Geotech Report and Design)</i>	0 <i>(Actual to be based on Geotech Report and Design)</i>

*Asphalt and granular base/sub-base thicknesses is to be considered a minimum and thinner sections will not be permitted.

*Maximum asphalt lift thickness is 50 mm.

*Minimum asphalt lift thickness is 40 mm.

*Surface course asphalt lift thickness to be 50 mm.

*Streets that are paved with base course asphalt only for Winter months to be minimum 50 mm.

6 STORMWATER MANAGEMENT

Division 6 of the Development Design Manual describes the stormwater management requirements.

6.1 HYDROLOGY

Developers shall either use an acceptable model or regression equations to calculate the climate-change stormwater surface runoff.

6.1.1 MODELLING

Developers may use a stormwater management software acceptable to the City to determine the climate-change stormwater surface runoff. The methods and parameters will be as provided by PERS Staff.

6.1.2 REGRESSION EQUATION

Developers may alternatively calculate the climate-change stormwater surface runoff using the following regression equation:

$$Q = b + m_1Area + m_2Length + m_3Slope \quad (6.1)$$

Where:

b , m_1 , m_2 , m_3 are coefficients (see Table 6-1 and Table 6-2),

Q = Stormwater surface runoff, in cubic meters per second

Area = Drainage area delineated from 1m contours, in hectares,

Length = Longest overland flow path length of the drainage area, in meters,

Slope = Average slope along length, in meter per meter.

The stormwater volume generated by the stormwater surface runoff in Equation (6.1) is:

$$V_Q = 1000Q \quad (6.2)$$

Where:

V_Q = Volume of stormwater surface runoff, in cubic meters

Q = Stormwater surface runoff, in cubic meters per second

6.1.2.1 RESIDENTIAL DEVELOPMENT

Table 6-1 - Residential Development Regression Equation Coefficients

Return Period (Years)	b	m ₁	m ₂	m ₃
2	0.01173	0.15168	-0.00026	0.98818
5	0.02498	0.24323	-0.00044	1.66448
10	0.03486	0.31450	-0.00061	2.35136
25	0.04147	0.41031	-0.00075	2.87300
50	0.00728	0.49968	-0.00083	3.17864
100	0.05319	0.55303	-0.00094	3.44885

NOTE: The coefficients in Table 6-1 are valid for drainage areas up to and including 5 hectares. Areas larger than 5 hectares shall be broken down into subareas less than 5 hectares. Stormwater surface runoff from landscaping in Residential areas is accounted for in these equations.

Residential developments applicable to the coefficients in Table 6-1 would be: single family dwellings, semi-detached dwellings, duplexes, and townhouses. Multi-unit Residential developments such as apartment buildings or condominium buildings with parking lots shall use the coefficients in Table 6-2 for calculating stormwater runoff.

Example 6.1.1

A new Residential cul-de-sac Development has an overall area of 1.95 hectares, an overland flow path length of 260 meters, and an average slope of 0.0330 meter per meter. The new Development will connect to an existing local storm sewer which has the capacity to convey the 2-year event. Calculate the pre-development (2-year) and post-development (100-year) flows and the required stormwater storage detention volume.

Based on Equations (6.1) and (6.2) and Table 6-1, the pre-development flow (Q_{Pre}), post-development flow (Q_{Post}), and required stormwater detention volume ($V_{Storage}$) are calculated as follows:

$$Q_{Pre} = 0.01173 + 0.15168(1.95) - 0.00026(260) + 0.98818(0.0330) = 0.270 \text{ cms}$$

$$Q_{Post} = 0.05319 + 0.55303(1.95) - 0.00094(260) + 3.44885(0.0330) \\ = 1.000 \text{ cms}$$

$$V_{Storage} = 1000(1 - 0.27) = 730 \text{ cm}$$

6.1.2.2 NON-RESIDENTIAL DEVELOPMENT

Table 6-2 - Non-Residential Development Regression Equation Coefficients

Return period (Years)	b	m ₁	m ₂	m ₃
2	0.01748	0.17917	-0.00036	1.34500
5	0.02784	0.27953	-0.00053	2.04124
10	0.03476	0.35410	-0.00068	2.56188
25	0.03895	0.44955	-0.00078	2.87642
50	0.04097	0.51987	-0.00083	3.01321
100	0.04781	0.59001	-0.00091	3.25782

NOTE: The coefficients in Table 6-2 are valid for drainage areas up to and including 5 hectares. Areas larger than 5 hectares will need to be broken down into subareas less than 5 hectares. Stormwater surface runoff due to landscaping is accounted for in these equations.

Non-Residential developments applicable to the coefficients in Table 6-2 would be: Commercial, Industrial, and Institutional development; as well as, apartment buildings or condominium buildings with parking lots. If you are unsure of which table to use with Equation (6.1) then speak with the Manager of Development Engineering before proceeding with any computations.

Example 6.1.2

A 10,000 square meter Commercial Office building with a 450-stall parking lot has an overall development area of 4.0 hectares, an overland flow path length of 250 meters, and an average slope of 0.0400 meter per meter. The new Development will connect to an existing trunk storm sewer which has the capacity to convey the 25-year event. Calculate the pre-development (25-year) and post-development (100-year) flows and the required stormwater storage detention volume.

Based on Equations (6.1) and (6.2) and Table 6-2, the pre-development flow (Q_{Pre}), post-development flow (Q_{Post}), and required stormwater detention volume ($V_{Storage}$) are calculated as follows:

$$Q_{Pre} = 0.03895 + 0.44955(4.0) - 0.00078(250) + 2.87642(0.0400) = 1.760cms$$

$$Q_{Post} = 0.04781 + 0.59001(4.0) - 0.00091(250) + 3.25782(0.0400) = 2.310cms$$

$$V_{Storage} = 1000(2.31 - 1.76) = 550cm$$

6.1.3 DRAINAGE AREA

The Developer shall provide a current Legal Survey and Description indicating the boundaries of the Developer's land for the area of interest and clearly indicating on the

survey the area that will be developed (to be known thus forth as the “Development Area”).

6.1.3.1 PRE-DEVELOPMENT DRAINAGE AREA

The pre-development drainage area for stormwater management shall be determined from the City’s latest contour mapping using a one-meter contour interval. However, the pre-development drainage area shall be no larger than the development area and the boundaries of the pre-development drainage area shall not extend outside the development area. Furthermore, only the area(s) that naturally drain to the proposed point of connection (i.e. manhole, catchbasin, headwall, or ditch inlet) from the Development to the existing or new storm sewer system or watercourse shall be included in the pre-development area.

6.1.3.2 POST-DEVELOPMENT DRAINAGE AREA

The post-development drainage area for stormwater management shall be determined from the City’s latest contour mapping using a one-meter contour interval and proposed site elevations. **The post-development area shall be equal to or greater than the pre-development area.** Runoff from upstream lands not being developed (as part of this application or anytime in the future) which contributes to the development area must be managed appropriately to an acceptable discharge point with sufficient capacity. In order to limit the amount of runoff that will be captured by new stormwater infrastructure, such runoff may be captured and redirected to a downstream watercourse or storm sewer system that has the capacity to accommodate the diverted runoff. This may be accomplished with an approved interceptor ditch or berm structure. It will be the responsibility of the Developer to obtain the necessary Easements to redirect any runoff or conveyance of water over private property.

A PDF of the pre-development and post-development drainage areas (using a scale typically between 1:500 and 1:2500) shall be submitted for review and approval. The drainage area PDF shall include: the overall drainage area; all subareas (indicating subarea names and numeric value of areas in hectares); existing and proposed streets, existing and proposed footprints of buildings, driveways and parking lots; existing and proposed stormwater infrastructure; existing and proposed waterways, floodplains, wetlands and buffers; and contours in one-meter intervals. See Figure 6-1 for a simplified example of a Residential subdivision drainage area plan. The Developer must submit a NAD83 georeferenced CAD drawing and a NAD83 georeferenced ArcGIS polygon shapefile of the drainage area(s).

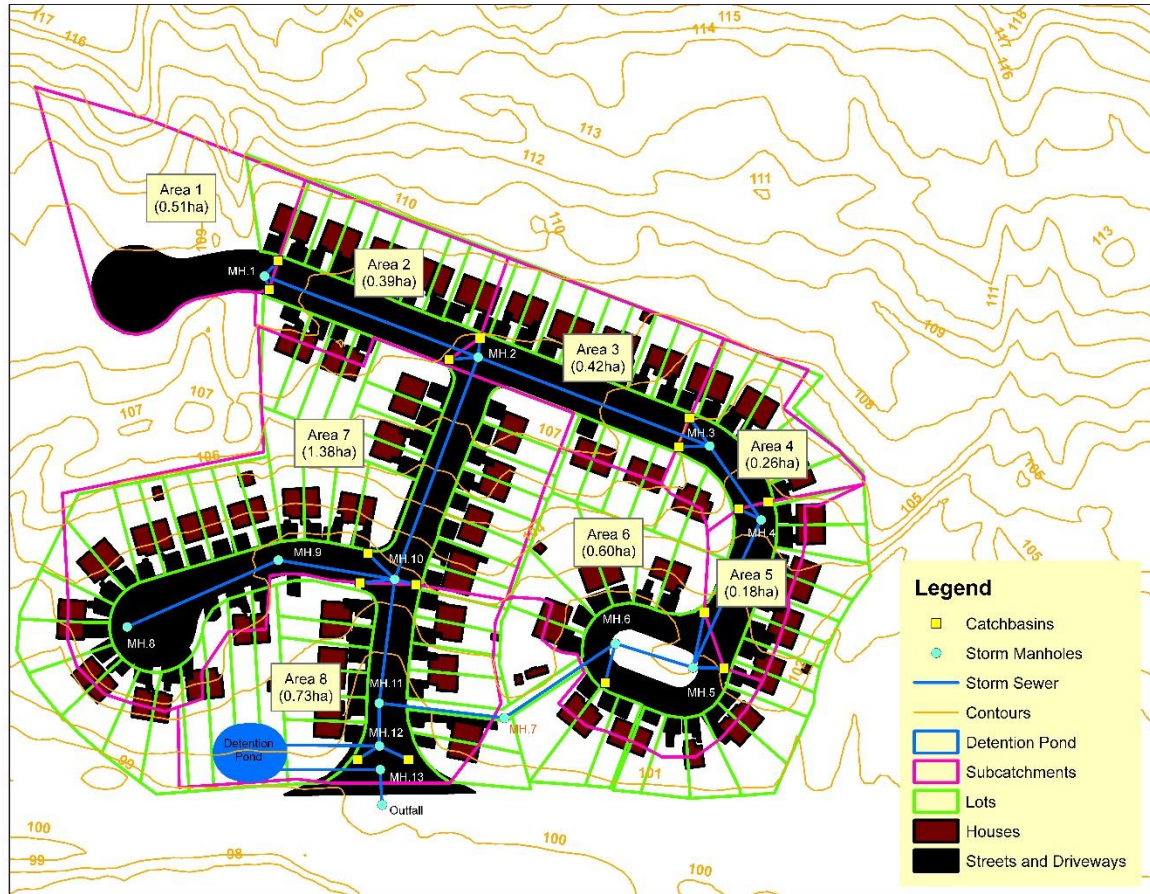

Figure 6-1 - Residential Subdivision Drainage Area Plan

NOTE: In Figure 6-1 it is assumed that undeveloped upland drainage will be captured by an interceptor ditch or berm and diverted around the Development thus minimizing the volume of stormwater captured by the piped system. For simplicity, existing infrastructure, pipe diameters and standard title blocks have been omitted.

6.1.4 FLOW PATH LENGTH AND SLOPE

The slope of the drainage area or subarea (in meter per meter) shall be the average slope along the longest route of overland flow from the highest elevation to the receiving stormwater infrastructure (i.e. catchbasin, headwall, ditch inlet, etc.). See Figure 6-2 for an example of the flow paths and slopes for each subarea in Figure 6-1.

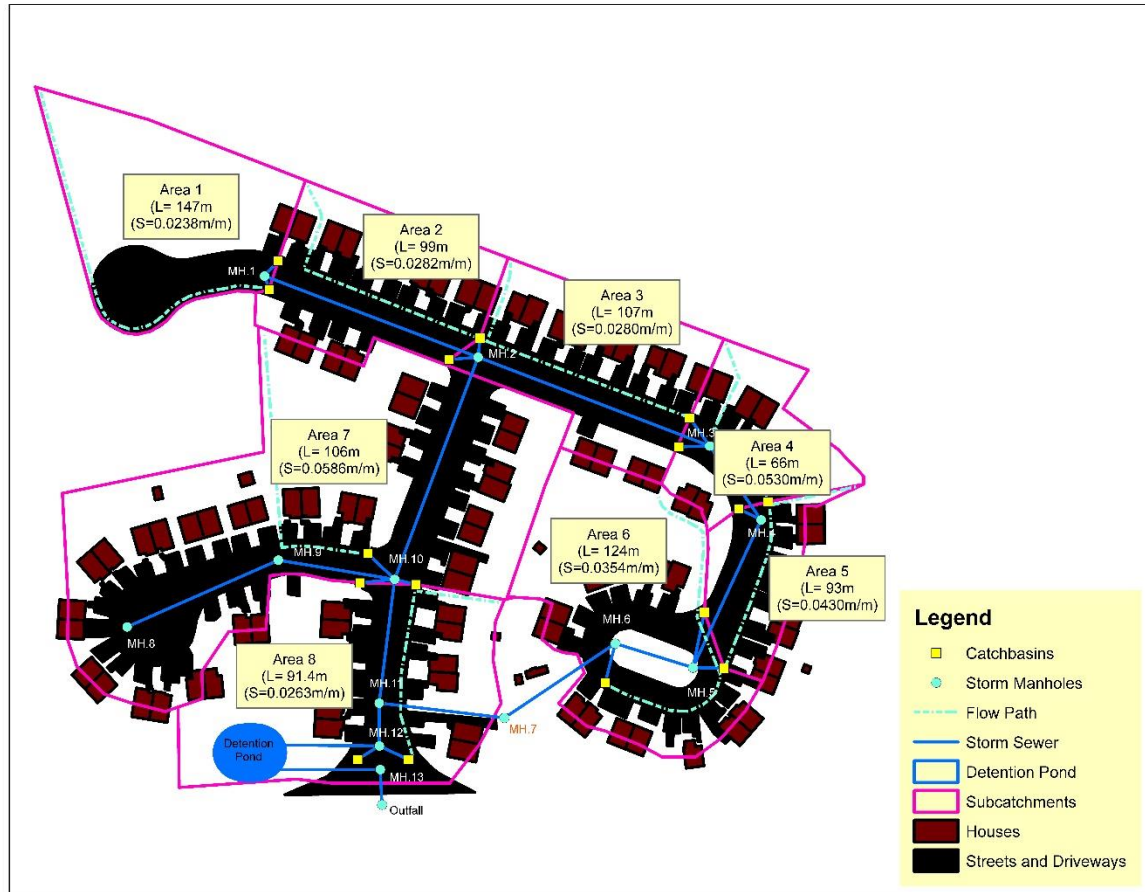

Figure 6-2 - Drainage Area Plan with Flow Paths and Flow Path Slopes

A NAD83 georeferenced ArcGIS polyline shapefile which contains the above referenced overland flow path(s) must be submitted for review and include in the attribute table the following: upper and lower flow path elevations, flow path lengths, and slope for each flow path.

6.1.5 PRE-DEVELOPMENT FLOWS

Stormwater surface runoff from developments shall not exceed the pre-development flows calculated from either Equation (6.1) or by modelling using the return periods in Table 6-3 and based on the connection point to the City's stormwater management system. Upon request the City will calculate the pre-development flow for a proposed Development if the Developer provides a current legal survey plan and description and a pre-development drainage area plan for the land being developed.

Table 6-3 - Pre-Development Return Periods

Connection Point	Pre-development Return period
Older Local Storm Sewers (not designed for climate change)	2-Year
New Local Storm Sewers (designed for climate change)	10-Year
Older Trunk Storm Sewers (not designed for climate change)	10-Year
New Trunk Storm Sewers (designed for climate change)	25-Year
Older Drainage Ditches and culverts (not designed for climate change)	10-Year
New Drainage Ditches and culverts (designed for climate change)	25-Year
Watercourses*	25-Year

* When computer modelling is used, the pre-development return period for watercourses will be as determined by the City.

In situations where the above table is not applicable then the City will set the pre-development flow rate for the Development.

6.1.6 POST-DEVELOPMENT FLOWS

All post-development flows shall be calculated for the 100-year event using either Equation (6.1) or by modelling. The calculation of flows for other return periods may also be required, depending on the type of development.

6.2 HYDRAULICS

There are numerous types of structures used in stormwater management systems. Conveyance can be as simple as a roadside ditch or as complex as a dendritic system of underground pipes with inlets, control structures, and various types of stormwater storage facilities. The following sections deal with some of the more rudimentary structures and the hydraulics associated with those structures.

6.2.1 STORM SEWER HYDRAULICS

A storm sewer is defined as an underground closed conduit which commences with an upstream manhole, catchbasin, or ditch inlet and terminates with a downstream manhole, catchbasin or headwall. The hydraulic analysis of storm sewers shall be done using Manning's Equation and capacity shall be based on the pipe flowing full under gravity with no surcharge. The capacity of a storm sewer flowing full under gravity is given by Equation (6.3). Equation (6.3A) is a simplified version for circular pipes. Equation (6.3B) is Equation (6.3A) solved for D.

$$Q = \frac{AR^{0.667}S^{0.5}}{n} \quad (6.3)$$

$$Q = \frac{0.312D^{2.667}S^{0.5}}{n} \quad (6.3A)$$

$$D = \left(\frac{3.208Qn}{S^{0.5}} \right)^{0.375} \quad (6.3B)$$

Where:

Q = Full pipe flow, in cubic meters per second

A = Cross-sectional area of pipe, in square meters

R = Hydraulic radius in meters = (D/4) for a circular pipe

D = Diameter of pipe, in meters

S = Longitudinal slope of pipe, in meter per meter

n = Manning's coefficient

Table 6-4 below indicates Manning's coefficients for typical pipe materials.

Table 6-4 - Manning's Coefficients for Storm Sewers

Material	Manning's n
Smooth Interior Wall Plastic (HDPE, PVC)	0.013
Smooth Interior Wall Concrete	0.013
Corrugated Metal (CMP)	minimum 0.024

NOTE: The City no longer allows CMP to be used for storm sewers or driveway culverts and 0.024 is a conservative number for cases where existing CMP storm sewers must be analyzed.

6.2.2 CULVERT HYDRAULICS

A culvert is defined as a pipe that conveys stormwater runoff from the surface through an inlet whose entrance is a headwall, a projecting end or a mitered end. The stormwater then travels underground through the conduit and then exits through the outlet of the culvert via a headwall, a projecting end, a mitered end or discharges into a manhole. Culverts are designed for either inlet control or outlet control. If the conveyance capacity of the pipe barrel is higher than what the entrance can accept then the inlet controls the flow condition - otherwise, the flow condition is controlled by the outlet. Equation (6.3) is not appropriate for analyzing flow through a culvert and the following methodology must be used.

6.2.2.1 INLET CONTROL FOR CULVERTS

If stormwater can flow through and out of the culvert faster than it can enter then the culvert is under inlet control. Flow capacity is controlled at the entrance by the headwater depth, cross-sectional area, and type of inlet. The roughness, length, and outlet conditions are not factors in determining capacity for inlet control. The flow is therefore controlled upstream and is limited to what can enter the culvert.

The equation used for the hydraulic analysis of a culvert under inlet control will vary depending on whether or not the inlet is submerged or unsubmerged. An inlet is considered to be unsubmerged if the following is true.

$$\frac{HW}{D} \leq 1.0 \quad (6.4)$$

Where:

HW = headwater depth, in meters, above the upstream culvert invert

D = diameter of circular culvert or height of rectangular culvert, in meters

Unsubmerged Culverts

For an unsubmerged culvert, it is optimal to design the culvert for $HW/D \leq 1$ using the following equation:

$$\frac{HW}{D} = \frac{y_c}{D} + \frac{V_c^2}{2gD} + K \left(\frac{1.811Q}{AD^{0.5}} \right)^M + K_s S \quad (6.5)$$

Where:

HW = Headwater depth, in meters, above the upstream culvert invert

y_c = Critical depth, in meters

V_c = Velocity at critical depth, in meters per second

D = Diameter or height of culvert in meters

K_s = 0.7 for mitered inlets and -0.5 for nonmitered inlets

S = Culvert longitudinal slope, in meter per meter

K and M = Constants, see Table 6-5

Q = Flow, in cubic meters per second

A = Cross-sectional area of pipe, in square meters

g = Gravitational acceleration = 9.8067 meters per second squared (m/s^2)

Table 6-5 - Inlet Control (Unsubmerged Culvert) Constants for Equation (6.5)

Shape & Material	Inlet Edge Description	K	M
Circular HDPE, PVC, Concrete	Square Edge with Headwall	0.0098	2.0
Circular HDPE, PVC, Concrete	Groove End with Headwall	0.0018	2.0
Circular HDPE, PVC, Concrete	Groove End Projecting	0.0045	2.0
Circular CMP	Square Edge with Headwall	0.0078	2.0
Circular CMP	Groove End with Headwall	0.0210	1.33
Circular CMP	Groove End Projecting	0.0340	1.5
Rectangular Concrete	30° to 75° Wingwalls	0.0260	1.00
Rectangular Concrete	90° and 15° Wingwalls	0.0610	0.75
Rectangular Concrete	0° Wingwalls	0.0610	0.75

NOTE: The City no longer allows CMP to be used for storm sewers or driveway culverts. Bottomless CMP structures are permitted at stream crossings provided they are constructed on concrete footings and as approved by the City.

Circular Culverts

The critical depth y_c for a circular culvert can be approximated by:

$$y_c = \frac{1.01Q^{0.5}}{D^{0.26}g^{0.25}} \quad (6.6)$$

The corresponding critical top width, T_c , critical area, A_c , and critical velocity, V_c , of a circular culvert are calculated from geometry as follows:

$$T_c = D \sin\left(\frac{\theta}{2}\right) \quad (6.7)$$

$$A_c = \frac{(\theta - \sin\theta)D^2}{8} \quad (6.8)$$

$$V_c = \frac{8Q}{(\theta - \sin\theta)D^2} \quad (6.9)$$

where

$$\theta = 2\cos^{-1}\left(1 - \frac{2y_c}{D}\right) \quad (6.10)$$

and θ is in radians

Circular culverts composed of concrete, PVC, or HDPE (each with smooth interior walls) which are constructed with square-edged ends and a headwall have the following capacities under inlet control for HW/D=1.0, see Table 6-6

Table 6-6 - Circular Culvert Capacities Under Inlet Control for Square-Edged Ends with Headwall

Diameter (mm)	Area (sm)	Slope 0%	Slope 2%	Slope 4%	Slope 6%	Slope 8%	Slope 10%
		Flow (cms)	Flow (cms)	Flow (cms)	Flow (cms)	Flow (cms)	Flow (cms)
300	0.071	0.064	0.065	0.066	0.067	0.068	0.069
400	0.126	0.133	0.135	0.136	0.138	0.140	0.141
500	0.196	0.232	0.235	0.238	0.241	0.244	0.247
600	0.283	0.367	0.372	0.376	0.381	0.386	0.390
700	0.385	0.539	0.546	0.553	0.560	0.567	0.574
800	0.503	0.753	0.763	0.773	0.782	0.792	0.802
900	0.636	1.012	1.025	1.038	1.051	1.063	1.076
1000	0.785	1.317	1.333	1.350	1.367	1.384	1.401
1200	1.131	2.077	2.104	2.130	2.157	2.183	2.210
1500	1.767	3.628	3.675	3.721	3.768	3.814	3.861
1800	2.545	5.723	5.797	5.870	5.943	6.016	6.089
2100	3.464	8.413	8.521	8.629	8.737	8.845	8.952
2400	4.524	11.747	11.897	12.049	12.199	12.349	12.499

Example 6.2.2

A circular concrete culvert has a diameter of 1.2m, a length of 20m, and a slope of 0.04 m/m. If the entrance to the culvert is a square edged headwall which must accommodate 2.13cms then determine the headwater-to-diameter ratio (HW/D) if the culvert operates under inlet control.

Procedure 6.2.2

(i) Determine cross-sectional area of culvert:

$$A = \frac{\pi D^2}{4} = \frac{\pi(1.2)^2}{4} = 1.13 \text{ sm}$$

(ii) Calculate y_c from Equation (6.6):

$$y_c = \frac{1.01(2.13)^{0.5}}{(1.2)^{0.26}(9.8067)^{0.25}} = 0.79 \text{ m}$$

(iii) Calculate θ from Equation (6.10):

$$\theta = 2\text{Cos}^{-1}\left(1 - \frac{2(0.79)}{1.2}\right) = 3.80 \text{ rad}$$

(iv) Calculate V_c from Equation (6.9):

$$V_c = \frac{8(2.13)}{(3.80 - \sin[3.80])(1.2)^2} = 2.68 \text{ m/s}$$

(v) Determine constants K_s , K and M :

$K_s = -0.5$ for non-mitered inlet, $K = 0.0098$ and $M = 2$ from Table 6-5

(vi) Calculate HW/D from Equation (6.5):

$$\frac{HW}{D} = \frac{0.79}{1.2} + \frac{2.68^2}{2(9.8067)(1.2)} + 0.0098 \left(\frac{1.811(2.13)}{1.13(1.2)^{0.5}} \right)^2 - 0.5(0.04) = 1.0$$

Results 6.2.2

A 1.2m diameter culvert diameter can accommodate a flow of 2.13cms with a $HW/D=1.0$.

Rectangular Culverts

The critical depth y_c for a rectangular culvert is estimated by:

$$y_c = \left(\frac{Q^2}{gb^2} \right)^{0.333} \quad (6.11)$$

Where b is the culvert width.

The corresponding critical area, A_c , and critical velocity, V_c , of a rectangular culvert are calculated from geometry as follows:

$$A_c = by_c \quad (6.12)$$

$$V_c = \frac{Q}{by_c} \quad (6.13)$$

Structural Plate Arch on Concrete Footings

Nomographs for structural plate steel and aluminium arches for inlet and outlet control shall be provided by the pipe Manufacturer as part of the review process.

Submerged Culverts

The submerged culvert formula for inlet control is primarily used when designing outlet control structures for stormwater detention facilities where it is necessary to analyse culverts under head or pressure flow. The formula for inlet control submerged culvert flow is given by Equation (6.14).

$$\frac{HW}{D} = c \left(\frac{1.811Q}{AD^{0.5}} \right)^2 + Y - 0.5S^2 \quad (6.14)$$

Where:

HW = Headwater depth (in meters) above the upstream culvert invert

D = Diameter of pipe, in meters
 S = Culvert longitudinal slope, in meter per meter
 c and Y = Constants, see Table 6-7
 Q = Flow, in cubic meters per second
 A = Cross-sectional area of pipe, in square meters

Table 6-7 - Inlet Control (Submerged Culvert) Constants for Equation (6-14)

Shape & Material	Inlet Edge Description	c	Y
Circular HDPE, PVC, Concrete	Square Edge with Headwall	0.0398	0.67
Circular HDPE, PVC, Concrete	Groove End with Headwall	0.0292	0.74
Circular HDPE, PVC, Concrete	Groove End Projecting	0.0317	0.69
Circular CMP	Headwall	0.0379	0.69
Circular CMP	Mitered to Slope	0.0463	0.75
Circular CMP	Projecting	0.0553	0.54
Rectangular Concrete	30° to 75° Wingwall Flares	0.0347	0.81
Rectangular Concrete	90° and 15° Wingwall Flares	0.0400	0.80
Rectangular Concrete	0° Wingwall Flares	0.0423	0.82

6.2.2.2 OUTLET CONTROL FOR CULVERTS

If stormwater can flow into the culvert faster than it can flow through and out then the culvert is under outlet control. In that case, the flow is controlled downstream and limited to what the pipe can carry. Subsequently, the roughness in the culvert impacts flow capacity as does the difference in headwater and tailwater depth.

For full flow conditions under outlet control:

$$HW = T_w - SL + \left(1 + K_c + \frac{2gn^2L}{R^{1.333}} \right) \frac{Q}{2gA^2} \quad (6.15)$$

Where:

HW = Headwater depth, in meters, above the upstream culvert invert

T_w = Tailwater depth, in meters (T_w can be estimated by calculating normal depth in the downstream open channel)

S = Culvert slope, in meter per meter

L = Culvert length, in meters

K_c = Entrance loss coefficient from Table 6-8 below

Q = Flow, in cubic meters per second

A = Cross-sectional area of pipe, in square meters

g = Gravitational acceleration = 9.8067 meters per second squared

n = Manning's roughness factor

R = Hydraulic radius=A/P

P = Wetted perimeter, in meters

This equation includes friction losses as well as entrance and exit losses.

Table 6-8 - Entrance Loss Coefficients

Shape & Material	Inlet Edge Description	K_c
Circular HDPE, PVC, Concrete	Square Edge with Headwall	0.5
Circular HDPE, PVC, Concrete	Groove End with Headwall	0.2
Circular HDPE, PVC, Concrete	Groove End Projecting	0.2
Circular CMP	Headwall	0.5
Circular CMP	Mitered to Slope	0.7
Circular CMP	Projecting	0.9
Rectangular Concrete	30° to 75° Wingwalls	0.4
Rectangular Concrete	90° and 15° Wingwalls	0.5
Rectangular Concrete	0° Wingwalls	0.7

When designing a culvert, calculations are made for both inlet and outlet control and the headwater depths are compared for both conditions. The largest headwater depth will determine whether the inlet or the outlet controls and the culvert shall be designed for the largest headwater depth. The ratio of HW/D shall not exceed unity for the culvert that is chosen for design.

6.2.3 OPEN CHANNEL HYDRAULICS

Open channels are commonplace in both natural and constructed settings. They occur as watercourses, drainage ditches, swales, and gutters and have a free water surface at atmospheric pressure. This Manual will focus on trapezoidal channels associated with watercourses, drainage ditches and swales; as well as a simplified version of the triangular channel formed by gutters within urban street cross-sections.

6.2.3.1 TRAPEZOIDAL OPEN CHANNELS

The geometric cross-sectional properties of a trapezoidal channel can be extracted from Figure 6-3:

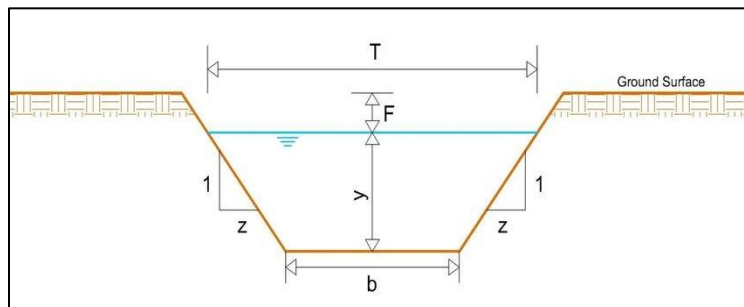

Figure 6-3 - Trapezoidal Channel

The Freeboard (F) is defined as the vertical distance between the free water surface and the ground surface (top of bank) and is typically 0.3m. The Flow Area (A), Wetted perimeter (P) of the Flow Area, Hydraulic Radius (R) of the Flow Area, and Top Width (T) of the free water surface are given by:

$$A = by + zy^2 \quad (6.16)$$

$$P = b + 2y\sqrt{1 + z^2} \quad (6.17)$$

$$R = \frac{by + zy^2}{b + 2y\sqrt{1 + z^2}} \quad (6.18)$$

$$T = b + 2zy \quad (6.19)$$

Substituting into Equation (6.3) yields the capacity equation for a trapezoidal open channel:

$$Q = \frac{(by + zy^2) \left[\frac{by + zy^2}{b + 2y\sqrt{1 + z^2}} \right]^{0.666} S^{0.5}}{n} \quad (6.20)$$

Where,

Q = Trapezoidal channel flow capacity, in cubic meters per second

B = Bottom width of open channel, in meters

Y = Depth of flow, in meters

Z = Horizontal component of side-slope ratio (eg. Z = 2 represents a 2H:1V sideslope)

S = Longitudinal slope of open channel, in meters per meter

n = Manning's roughness coefficient (minimum 0.035 for watercourse and drainage ditches)

6.2.3.2 TRIANGULAR OPEN CHANNELS (STREET GUTTER)

The geometric cross-sectional properties of a simplified gutter cross-section can be extracted from Figure 6-4:

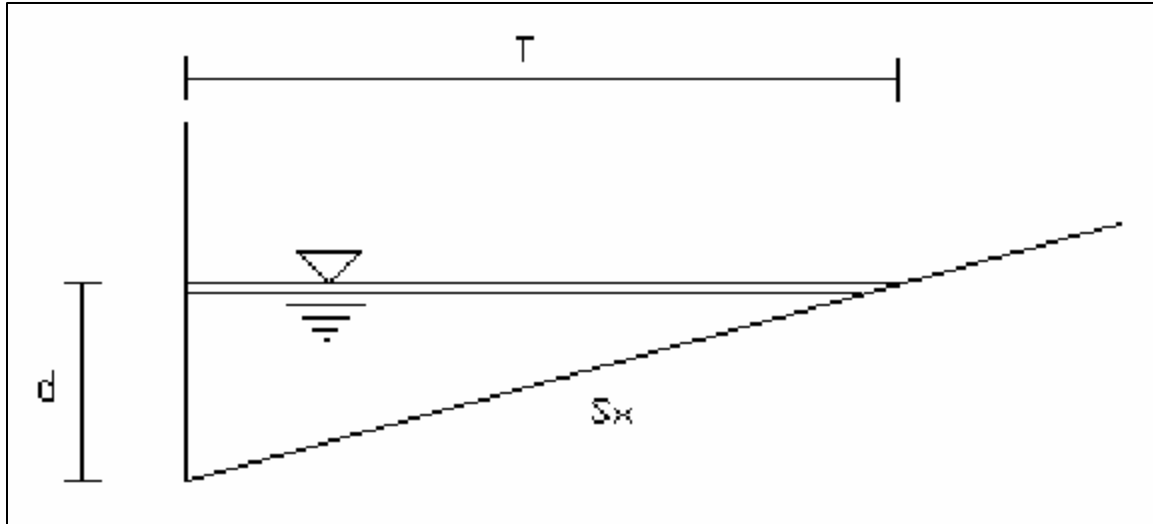

Figure 6-4 - Street Gutter Cross-Section

The depth of the curb is d (in meters) and the cross-slope of the road is S_x in meter per meter, where:

$$T = \frac{d}{S_x} \quad (6.21)$$

$$A = \frac{d^2}{2S_x} \quad (6.22)$$

$$P = d \left[1 + \sqrt{1 + \left(\frac{1}{S_x}\right)^2} \right] \quad (6.23)$$

$$R = \frac{d}{2S_x \left[1 + \sqrt{1 + \left(\frac{1}{S_x}\right)^2} \right]} \quad (6.24)$$

Substituting into Equation (6.3) yields the capacity equation for a street gutter:

$$Q = \left(\frac{d^2}{2nS_x} \right) \left[\frac{d}{2S_x \left[1 + \sqrt{1 + \left(\frac{1}{S_x}\right)^2} \right]} \right]^{0.666} S^{0.5} \quad (6.25)$$

Where,

Q = Gutter flow capacity, in cubic meters per second

d = Depth of gutter flow at the curb, in meters – maximum depth 0.15m

S_x = Cross-slope of the street, in meter per meter

S = Longitudinal slope of the gutter, in meter per meter

n = Manning's roughness coefficient (typically 0.020 for a street)

6.2.4 CATCHBASINS

Continuous Grade Catchbasins

Catchbasins can be located on continuous grades or within sags. A catchbasin is considered to be on a continuous grade if there is a flow-through condition and the catchbasin will only capture a portion of the gutter flow, see Figure 6-5 below.

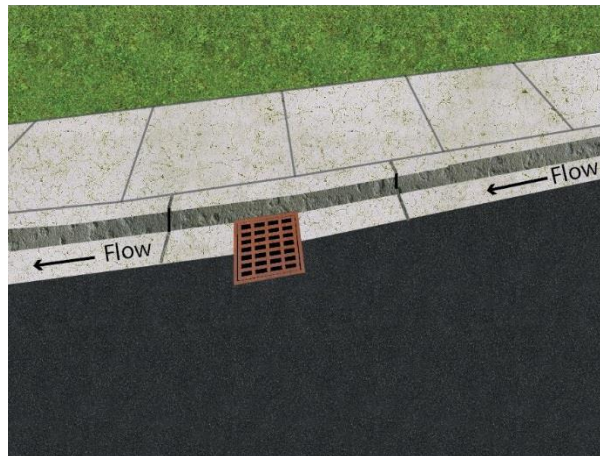

Figure 6-5 - Single Catchbasin on a Continuous Grade

For continuous grades the amount of gutter flow that is captured by the catchbasin is based on flow depth in the gutter and the longitudinal slope of the gutter approaching the catchbasin as indicated in Equation (6.26).

$$Q_{CB} = -0.02694 + 0.7642d - 0.1100S \quad (6.26)$$

Where:

Q_{CB} = Flow, in cubic meters per second, captured by continuous grade catchbasin

d = Depth of gutter flow at the curb, in meters. Maximum allowable depth is 0.15 meters

S = Longitudinal slope of the gutter, in meter per meter

Example 6.2.4 A

A gutter with a longitudinal slope of 0.040 meters per meter and a cross-slope of 0.020 meters per meter discharges a flow of 0.300 cubic meters per second to a location where a continuous grade catchbasin will be required. Determine the flow that a single

catchbasin can accommodate for these conditions and calculate the number of catchbasins required to capture all gutter flow. Assume Manning's $n = 0.025$

Procedure 6.2.4 A

Solving Equation 6.25 for d yields:

$$d = \left\{ \left(\frac{3.1478nS_x^{5/3}Q}{\sqrt{S}} \right) \left[1 + \sqrt{1 + \left(\frac{1}{S_x} \right)^2} \right]^{2/3} \right\}^{3/8}$$

$$d = \left\{ \left(\frac{3.1478 * 0.025 * 0.020^{5/3} * 0.300}{\sqrt{0.040}} \right) \left[1 + \sqrt{1 + \left(\frac{1}{0.020} \right)^2} \right]^{2/3} \right\}^{3/8}$$

$d = 0.104\text{m}$ which is the depth of gutter flow and it is less than 0.15m .

Determine the flow captured by a single catchbasin using Equation (6.26) for d :

$$Q_{CB} = -0.02694 + 0.7642 * 0.104 - 0.1100 * 0.04 = 0.048\text{cms}$$

Results 6.2.4 A

Number of catchbasins required to capture 0.300cms is $0.300\text{cms}/0.048\text{cms}$ which implies 6 catchbasins or 3 double catchbasins are required.

Sag Catchbasins

A catchbasin is considered to be in a sag if there is a ponding condition and the longitudinal gutter slope from both directions grades toward the catchbasins, see Figure 6-6.

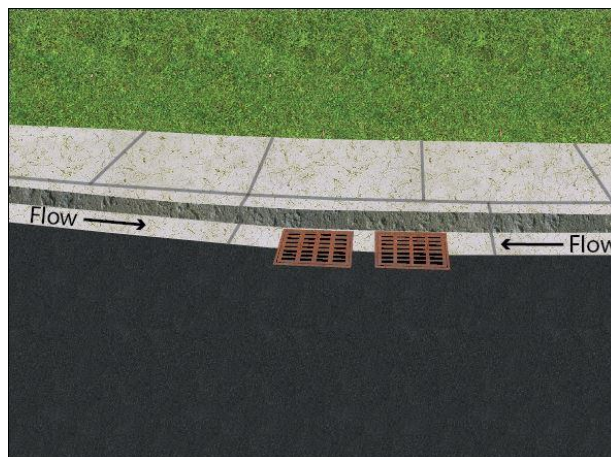

Figure 6-6 - Double Catchbasin in a Sag

For sag catchbasins the amount of flow that is captured is based on the depth of ponding over the catchbasin. The flow captured by a sag catchbasin can be calculated by Equation (6.27).

$$Q_{sag} = -0.001599 + 0.04952d + 5.347d^2 \quad (6.27)$$

Q_{sag} = Flow captured by a sag catchbasin, in cubic meters per second

d = Depth of ponding over the catchbasin, in meters. Maximum allowable depth of ponding is 0.15 meters.

A minimum of one double catchbasin is required in any sag area where the infrastructure will be owned and/or maintained by the City.

Example 6.2.4 B

A sag catchbasin is to be located in a lowpoint at an intersection where the North gutter draining to the lowpoint has a 0.05m/m slope conveying 0.250cms and East gutter discharging to the lowpoint has a 0.01m/m slope carrying a flow of 0.300cms. Check that the depths of flows in each gutter does not exceed 0.15m and determine the number of catchbasins required. Assume Manning's n is 0.025 and the cross-slopes of both streets is 0.02m/m.

Procedure 6.2.4 B

Calculate the depth of flow in each gutter:

$$d_{North} = \left\{ \left(\frac{3.1478 * 0.025 * 0.020^{\frac{5}{3}} * 0.250}{\sqrt{0.050}} \right) \left[1 + \sqrt{1 + \left(\frac{1}{0.020} \right)^2} \right]^{\frac{2}{3}} \right\}$$

$$d_{North} = 0.093m < 0.15m \text{ OK}$$

$$d_{East} = \left\{ \left(\frac{3.1478 * 0.025 * 0.020^{\frac{5}{3}} * 0.300}{\sqrt{0.010}} \right) \left[1 + \sqrt{1 + \left(\frac{1}{0.020} \right)^2} \right]^{\frac{2}{3}} \right\}$$

$$d_{East} = 0.135m < 0.15m \text{ OK}$$

Calculate Q_{sag} for a maximum permissible depth of 0.15m:

$$Q_{sag} = -0.001599 + 0.04952 * 0.15 + 5.347 * 0.15^2$$

$$Q_{sag} = 0.126cms$$

Calculate total flow from both gutters:

$$Q_{Total} = 0.250 + 0.300 = 0.550 \text{ cms}$$

Results 6.2.4 B

Number of required catchbasins = $0.550/0.126 = 4.4$. Use two double catchbasins and one single catchbasin.

6.2.5 DITCH INLETS

A ditch inlet is a special type of catchbasin with a specified sloped grate and a unique frame and cover typically used to convey flow from drainage ditches and areas outside of street Right-Of-Ways into a stormwater management system.

Ditch inlets can be precast devices using either 0.6m x 0.6m, 1m x 1m, or 1.2m x 1.2m grates with either a 2H:1V, 3H:1V, 4H:1V, or 6H:1V grate slope. Where a ditch inlet is placed across a ditch and is accessible to vehicular traffic then a 6H:1V grate slope shall be used.

The capacity of a ditch inlet grate is given by:

$$Q_{DI} = c_{DI}(0.003817 + 0.235d + 3.833d^2) \quad (6.28)$$

Where:

Q_{DI} = Flow accommodated by ditch inlet grate, in cubic meters per second per meter width (cms/m)

C_{DI} = Ditch inlet grate coefficient as per Table 6-9

d = Depth of flow at ditch inlet grate, in meters

Table 6-9 - Ditch Inlet Grate Coefficients

Grate Slope (H:V)	Coefficient, C_{DI}
2:1	1
3:1	1.5
4:1	1.75
6:1	2

Example 6.2.5

A trapezoidal open channel conveys 1.3cms to a proposed intake structure. The open channel has a longitudinal slope equal to 0.01m/m, a bottom width of 0.75m, side slopes of 2H:1V. Assuming a Manning's n of 0.035, determine the depth of flow, y, and determine which of the three standard ditch inlets is most suitable as an intake structure.

Procedure 6.2.5

Solving Equation 6.20 by trial and error for y

$$1.3 = \frac{(0.75y + 2y^2) \left[\frac{0.75y + 2y^2}{0.75 + 2y\sqrt{1 + 2^2}} \right]^{0.666} 0.01^{0.5}}{0.035}$$

yields $y = 0.54\text{m}$.

Try a 600mm x 600mm ditch inlet with a 2H:1V grate slope.

$$Q_{DI} = (0.003817 + 0.235 * 0.54 + 3.833 * 0.54^2) = 1.249 \text{ cms/m}$$

$$Q_{600 \times 600} = (0.6\text{m})(1.249\text{cms/m}) = 0.75\text{cms} < 1.3\text{cms} \text{ Not Suitable}$$

Try a 600mm x 600mm ditch inlet with a 4H:1V grate slope.

$$Q_{DI} = 1.75 * (0.003817 + 0.235 * 0.54 + 3.833 * 0.54^2) = 2.185 \text{ cms/m}$$

$$Q_{600 \times 600} = (0.6\text{m})(2.185\text{ms/m}) = 1.311 > 1.3\text{cms} \text{ OK}$$

Results 6.2.5

A 600mm x 600mm ditch inlet with a 4H:1V grate slope would be acceptable to accommodate an open channel flow of 1.3 cms.

6.2.6 OTHER INLETS

Other types of inlets (curb inlets, etc) may be accepted at the sole discretion of the City. The Developer must submit Manufacturer's specifications and rating curves to PERS for review and show to the City's satisfaction that neither catchbasins or ditch inlets are suitable for the use.

6.2.7 OUTLET CONTROL DEVICES

6.2.7.1 SMALL DIAMETER PIPES

Pipes 300mm diameter and larger can be used as outlet control devices for stormwater detention facilities. Outlet control pipes shall be sized in accordance with Section 6.1 and Section 6.2.2.1. For underground detention facilities, the head over the upstream invert of the outlet control pipe shall not exceed the obvert of the pipe or chamber that provides the storage. For aboveground detention systems, the head over the outlet control pipe's upstream invert shall not exceed the elevation of the invert elevation of the emergency overflow spillway or the top of bank, whichever is lower in elevation.

Example 6.2.6

An underground chamber having an internal height of 1.5m has a limiting pre-development flow of 0.214cms. Assuming the volume of the chamber is adequately sized for stormwater detention, what is the size of the pipe required to maintain pre-development flows?

Procedure 6.2.6

(i) Solve Equation (6.14) for D by trial and error assuming outlet pipe will be inlet controlled by a HDPE pipe (square edged with headwall) with 0.02m/m slope:

$$\frac{HW}{D} = c \left(\frac{1.811Q}{AD^{0.5}} \right)^2 + Y - 0.5S^2$$

$$\frac{1.5}{D} = 0.0398 \left(\frac{1.811(0.214)}{\frac{\pi}{4}D^2(D)^{0.5}} \right)^2 + 0.67 - 0.5(0.02)^2$$

Results 6.2.6

By trial and error, a 300mm pipe is required to limit pre-development flows to 0.214cms - provided the invert of the outlet control pipe is 1.5m below the obvert of the underground chamber.

6.2.7.2 ORIFICES

An orifice is a hole sized to provide a targeted flow rate given the head above the orifice control elevation. An orifice is used to draw down a storage detention volume over a period of time at a designated rate. A drawdown orifice shall always have a turned-down elbow on its upstream side to prevent trash and other debris from clogging the device.

The flow through an orifice is a function of : the area of the opening; the head over the centroid of the orifice, and the condition of the edge around the opening. The equation for the orifice is given in below in Equation (6.29).

$$Q = C_d A_o \sqrt{2gh_o} \quad (6.29)$$

Where:

Q = Flow through the orifice, in cubic meters per second

C_d = Discharge coefficient

A_o = Area of the orifice opening, in square meters

g = Acceleration of gravity, 9.8067 meters per second squared

h_o = Head over the centroid of the orifice, in meters

The discharge coefficient has a value of 0.60 for openings that are uniform, smooth and square-edged. For ragged edged openings a value of 0.40 shall be used. If the outlet of the orifice is or will be submerged then the head is equal to the difference between the upstream water surface elevation and the downstream water surface elevation.

6.2.7.3 WEIRS

A weir is a low head dam or barrier that alters the flow in a conduit resulting in a change in height of the water surface upstream of the weir. They are used as controls at the outlets of stormwater detention facilities as well as lakes, ponds, and reservoirs. A weir

installed perpendicular across the path of flow is called a longitudinal weir whereas a weir constructed parallel to the path of flow is referred to as a transverse weir. In this Manual three type of weirs will be discussed: longitudinal (broad-crested), longitudinal (narrow vertical slot), and transverse (broad-crested).

Longitudinal (broad-crested) weir

Longitudinal broad-crested weirs are common in stormwater detention facilities in the outlet as a primary control for the discharge. The discharge over a longitudinal broad-crested weir is given by Equation (6.30) where the flow is perpendicular to the weir.

$$Q = CL_e H^{1.5} \quad (6.30)$$

Where:

Q = Discharge over the weir, in cubic meters per second

C = Discharge coefficient=1.66

L_e = Effective length of the weir crest, in meters

H = Head of water above the crest of the weir, in meters

In most applications the weir crest does not completely extend across the path of flow and the correction in Equation (6.31) is applied for the flow contractions at each end of the weir.

$$L_e = L - 0.1nH \quad (6.31)$$

Where:

L_e = Effective length of the weir crest, in meters

L = Measured length of the weir crest, in meters

n = Number of end contractions

H = Head of water above the crest of the weir, in meters

Longitudinal (narrow vertical slot) weir

$$Q = 2.95C_s L H^{1.5} \quad (6.32)$$

Where:

Q = Discharge through the vertical slot, in cubic meters per second

C_s = Discharge constant for vertical slot = 0.562 + 11.354/R^{0.5}

L = Length of the weir crest, in meters

R = Hydraulic radius, in meters = wetted slot area / wetted slot perimeter

H = Head of water above the crest of the weir, in meters

A trial and error approach is required to solve Equation (6.32) and the formula for C_s.

Transverse (broad-crested) weir

Transverse broad-crested weirs can be used in stormwater detention facilities as an emergency overflow when the flow is parallel or close to parallel to the weir. The discharge over a transverse broad-crested weir is given by Equation (6.33).

$$Q = CL_e H^u \quad (6.33)$$

Where:

Q = Discharge over the weir, in cubic meters per second

C = Discharge coefficient=1.66

L_e = Effective length of the weir crest, in meters

H = Head of water above the crest of the weir, in meters

u = An exponent ranging between 1.5 and 2.5

6.2.7.4 PERFORATED RISER PIPE

Riser pipes are vertical pipes with perforations (i.e. small orifices) and the perforations are sized and placed to achieve an overall desired discharge rate from a stormwater detention facility.

Risers shall be constructed of reinforced concrete or smooth wall PVC or HDPE pipe which is structurally designed for the intended use. The minimum diameter of riser pipe is 600mm however riser pipes greater than 1.2m in height may need to have larger diameter and may require special bracing for structural support. All riser pipes shall be set into a cast-in-place concrete base. Riser pipes must be accessible and a special structure may be required for access purposes. The minimum size orifice in a riser pipe shall be 25mm. The top of the riser shall be enclosed and the cap shall be bolted to the riser pipe. The capacity of the riser pipe will be determined using Equation (6.26) in Section 6.2.6.

6.3 STORM SEWER DESIGN

The storm sewer system shall be designed as a separate system from the sanitary sewer system – new designs for combined systems are not permitted.

Storm sewers must be designed to convey all design flows with the hydraulic grade line (HGL) at or below the obvert of the storm sewer pipe.

Any storm sewer system or part of a storm sewer system shall be designed to serve the area within the Development boundary plus any areas which are tributary to the system.

6.3.1 STORM SEWER MANHOLES

All manholes and appurtenances shall conform to and be constructed as per the latest edition of the City of St. John's Specification Book. Where none of the standard

manholes detailed in the City of St. John's Specification Book are appropriate, then a non-standard manhole may be approved subject to the submission of fully detailed civil and structural Engineered drawings which have been stamped, signed, and dated by a Professional Engineer licensed to practice in the Province of Newfoundland and Labrador. Staff will review the proposed non-standard manhole and render a decision regarding its acceptability.

6.3.1.1 MANHOLE LOCATIONS

Manholes shall be located at every change of horizontal and vertical alignment, at every change of pipe size and/or material, and at dead ends. No manholes are to be located within 3.0 m of an overhead electrical line. Manholes shall be clear of curb and gutters and clear of bends in the road for new construction.

Storm manholes located within street Right-Of-Ways shall be placed in the quarter-point of the driving surface, wherever possible.

6.3.1.2 MANHOLE SPACING

The maximum allowable spacing for new storm sewer main manholes shall be 120m. However, shorter spacings will usually be required in order to ensure there are sufficient collections points along the street to limit the maximum depth of gutter flow to 0.15m.

6.3.1.3 MANHOLE SIZING

All sizing of storm sewer main manholes is based on inlet and outlet pipe sizes and manholes shall be sized according to the standard drawings in the latest version of the City of St. John's Specification Book. The minimum internal diameter for precast concrete manholes is 1200mm.

The type and size of storm manholes shall be specified on the profile drawings. When any dimension of a proposed storm manhole differs from the City of St. John's Specification Book then that storm manhole shall be individually designed and detailed by a Structural Engineer licenced to practice in the Province of Newfoundland and Labrador. Structural drawings and details shall be submitted to the City for review.

6.3.1.4 MANHOLE ACCESS FRAMES AND COVERS

Manhole access frames and covers are required for all manholes and will be in accordance with the City of St. John's Specification Book. All manhole access frames and covers shall be located on the upstream side of the manhole.

6.3.1.5 LOCKABLE MANHOLE COVERS

The City will require lockable watertight manhole covers on pump stations, flow monitoring stations, and other locations as deemed necessary by the City.

6.3.1.6 MANHOLE LADDER RUNGS

All manholes shall have aluminium climbing steps (ladder rungs) as per the City of St. John's Specification Book.

6.3.1.7 MANHOLE DROP STRUCTURES

External drop pipes shall be provided when the difference in invert elevations between the inlet and the outlet pipe inverts is greater than 1.0 meters. The external drop pipe shall be one size smaller than the storm sewer main but the drop pipe shall be no smaller than 200mm diameter. At the City's sole discretion, a drop manhole may not be permitted. External drop manholes shall be constructed as per the standard detail in the City of St. John's Specification Book.

Internal drop pipes – if considered – require the internal manhole diameter to be increased by at least one pipe size and it must be demonstrated that access will not be compromised. Internal drop pipes shall be secured to the interior wall of the manhole by an approved fastening method. Internal drop pipes may be considered if the use of an external drop pipe, in the sole discretion of the City, is not possible.

6.3.1.8 MANHOLE SAFETY LANDINGS

If the depth from the storm sewer main manhole invert to the finished manhole cover elevation exceeds 5.0 meters then a safety landing shall be provided. Additional safety landing shall not be more than 5.0 meters apart. Access hatches in safety landings shall line up to allow proper use of fall arrest equipment.

6.3.1.9 MANHOLE BENCHING

Benching of storm manholes shall conform with the City of St. John's Specification Book. Benching height shall extend from the bottom of the manhole up to the pipe obverts to improve hydraulic performance. If there is an intent to differ from the City of St. John's Specification Book then a benching detail must be provided on the Engineering drawings for review.

6.3.1.10 HYDRAULIC LOSSES AT MANHOLES

Suitable drops shall be provided across manholes to compensate for the energy losses due to flow velocity changes and to accommodate the difference in the depth of flow between the upstream and downstream sewer pipes. The minimum invert drop across a manhole shall be the greater of: (a) the difference in the diameters of the upstream and downstream storm sewer mains; or (b) as calculated by Equation (6.34). To maintain a continuous energy gradient through manholes, the obvert elevation of the lowest upstream sewer main shall be equal to, or higher than, the obvert of the downstream sewer main.

$$H = \frac{k(V_2^2 - V_1^2)}{2g} \quad (6.34)$$

Where:

H = Head Loss, in meters

V₁ = Entrance Velocity, in meters per second

V₂ = Exit Velocity, in meters per second

g = 9.81 meters per second squared

k = coefficient (dimensionless)

= 0.04 for 0 degree angle

= 0.3 for 22.5 degree angle

= 0.4 for 45 degree angle

= 0.7 for 90 degree angle

The minimum drop for a straight run is 50mm and for a 90 degree angle is 150mm.

The Design Engineer shall strive to keep entrance velocities and exit velocities equal.

No decrease in pipe diameter from a larger size upstream to a smaller size downstream will be allowed regardless of an increase in pipe slope.

6.3.2 STORM SEWER PIPES

All storm sewer pipes shall conform to and be constructed as per the latest edition of the City of St. John's Specification Book.

6.3.2.1 MINIMUM PIPE SIZE

The minimum diameter of storm sewer pipes shall be as follows:

Storm Sewers Mains (Residential areas) - 300 mm

Storm Sewer Mains (Commercial/Industrial/Institutional areas) - 375 mm

Catch Basin Leads - 300 mm

Storm Sewer Service Laterals - 100 mm

Stormwater Detention Outlet Control Pipes - 300mm

6.3.2.2 VELOCITY

The minimum acceptable velocity at design peak flow shall be 1.0 m/s.

The maximum acceptable velocity at design peak flow shall be as follows:

4.5 m/s Pipes equal to or less than 600 mm in diameter,

6.0 m/s Pipes greater than 600 mm and equal to or less than 1200 mm in diameter, and

7.5 m/s Pipes with diameters greater than 1200 mm.

Where design velocities in excess of 3.0 m/s are proposed, provisions must be made to protect against displacement of sewers by sudden jarring or movement. Supercritical flow in storm sewers shall not occur unless provisions are made in the design to address structural stability and durability concerns. Anchors are required on pipes where pipe slope is equal to or greater than 33% or as requested by the City.

6.3.2.3 MINIMUM COVER

For public storm sewers, the minimum depth of cover from the pipe obvert to finished grade is 1.2m – a cover depth greater than 1.2m is recommended. For private storm sewers, the minimum depth of cover from pipe obvert to finished grade is 1.0m or the Manufacturer's recommended cover, whichever is greater – a cover greater than 1.0m is preferable for frost protection.

6.3.2.4 MAXIMUM COVER

For storm sewers, a maximum depth of cover from the pipe obvert to finished grade shall be 4m. The City may allow greater depths of cover in special circumstances.

6.3.2.5 MINIMUM GRADIENT

The minimum allowable pipe gradient shall be the gradient required to produce the minimum acceptable velocity of 1.0 m/s at design peak flow, except that, in no case, shall the minimum gradient be less than 0.5%.

6.3.2.6 CHANGE OF PIPE SIZE

No decrease of pipe size from a larger size upstream to a smaller size downstream shall be allowed under any circumstances.

6.3.2.7 STORM LATERALS

Storm sewer service laterals must not be located within 3.0 m of the side boundary of a building lot. For Residential building lots, storm sewer service pipes must connect to the storm sewer main using a tee and connections to storm sewer manholes will not be permitted. Commercial Development storm laterals must connect to a storm sewer manhole.

Storm sewer lateral connections to storm sewer mains shall not be deeper than 4m to the obvert of the main. A secondary storm sewer may be necessary to allow for servicing.

6.3.3 CATCHBASINS

Catchbasins shall be designed and constructed as per Item 223 of the City of St. John's Specification Book. Where none of the standard catchbasins detailed in the City of St.

John's Specification Book are appropriate, then a non-standard catchbasin may be approved subject to the submission of fully detailed civil and structural engineered drawings which have been stamped, signed, and dated by a Professional Engineer licensed to practice in the Province of Newfoundland and Labrador. Staff will review the proposed non-standard catchbasin and render a decision regarding its acceptability. Determination of acceptability will be in the sole discretion of the City.

As a minimum, two double catchbasins must be installed every 120 meters on City streets. However, additional catchbasins may be required to ensure that the maximum gutter flow depth does not exceed 0.15m.

Catchbasins at street intersections and their subsequent low points shall be located immediately upstream of sidewalk or pedestrian crossings. For street intersection with a continuous grade around a corner, catchbasins shall be located at the end-of-curve (EC) or beginning-of-curve (BC) of the curb radii on the uphill side. Catchbasins shall not be located in front of driveways.

No catchbasins are to be located within 3 meters of an overhead electrical line.

All catchbasins in low points or sags shall have at least one double-catchbasin.

6.3.4 CATCHBASIN LEADS

Single catchbasin leads and double catchbasin leads shall have a minimum diameter of 300 mm.

Catchbasin leads shall have a minimum grade of 2%.

The maximum length of catchbasin lead shall be 30 m.

Public catchbasin leads shall connect directly to a storm manhole.

6.3.5 RETURN PERIODS

The following infrastructure shall be designed for the noted return periods:

Local storm sewers	10-year minimum
Trunk storm sewers	25-year minimum
Roadside ditches, swales and culverts	25-year minimum
Streets/gutters	100-year
Parking lots	100-year
River culverts and bridges	100-year
Stormwater detention and retention facilities (including sewers leading to such facilities)	100-year
Dams	100-year to Probable Maximum Flood {PMF}, as directed by the City

The above referenced return periods are considered minimums and the City in its sole discretion may require more stringent return periods for design on a case-by-case basis.

6.4 STORMWATER DETENTION

Stormwater detention facilities shall be designed to limit flows to the City approved pre-development release rate. All detention facilities shall be designed to store the volume for the 100-year return period less the volume for pre-development based on Section 6.1. Stormwater detention is applicable to all development within the City with the exception of the following:

- i. Developments that can manage the entirety of their stormwater runoff using stormwater retention will not be required to provide stormwater detention.
- ii. Downtown, see Figure 6-7.
- iii. Quidi Vidi, see Figure 6-8.
- iv. East White Hills, see Figure 6-9.
- v. Residential infill development with an overall area equal to 1,500 square meters or less will be permitted without stormwater detention. The City may require that Residential infill structures be constructed with slab-on-grade foundations where there are capacity issues with the existing stormwater management system.
- vi. Non-Residential developments (Commercial, Industrial, Institutional, flat roof apartment buildings/condos, parking lots, etc.) with an overall site area equal to 565 square meters or less will be permitted without stormwater detention.
- vii. Cemeteries, grassed sports fields, and grassed parklands are exempt. Any parking lots associated with these uses are subject to stormwater detention.
- viii. Other areas may be exempt with the approval of Council.

In all cases listed above, the receiving system must be able to manage the increase in flow. If not, then stormwater detention will be required.

Stormwater detention facilities that use berming or embankments to contain stormwater may be subject to a dambreak analysis and risk assessment using the latest version of “Dam Safety Guidelines 2007” by the Canadian Dam Association.

Rooftop storage is not permissible and the City will not consider the attenuation of stormwater runoff using rooftop storage as a means of providing stormwater detention.

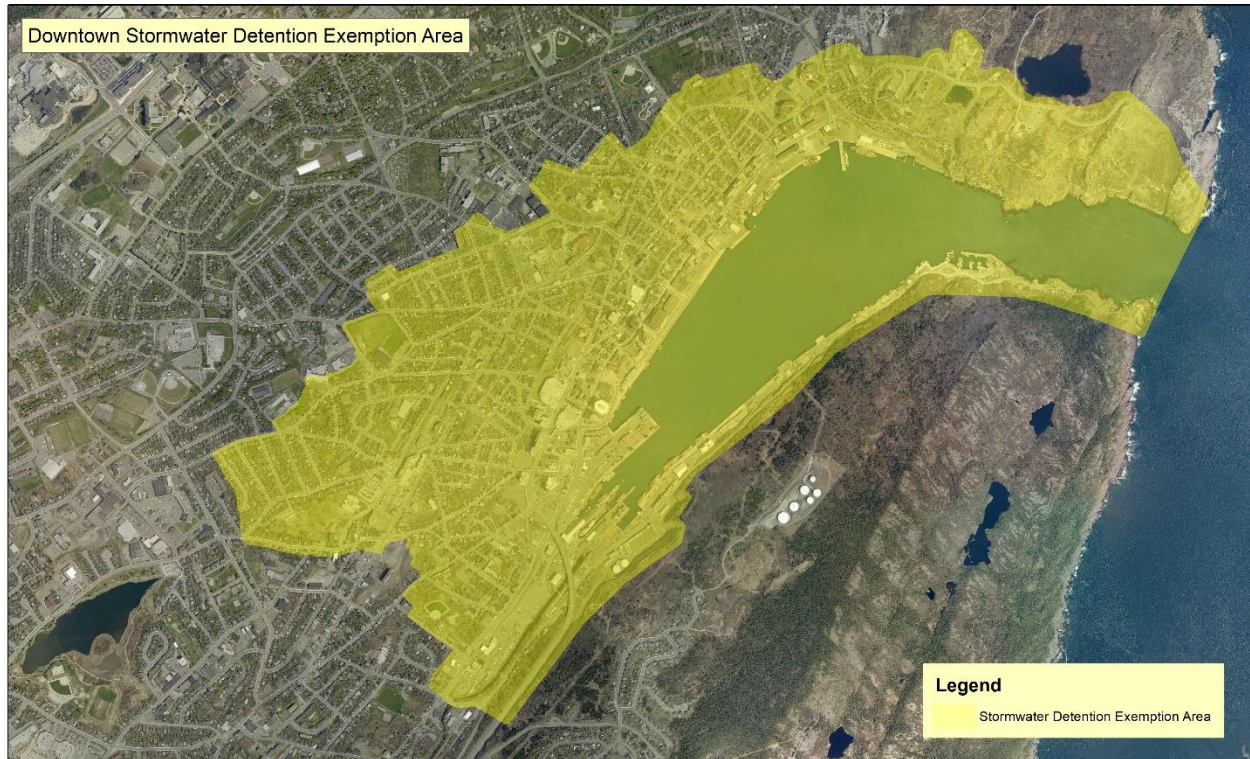

Figure 6-7 - Downtown Stormwater Detention Exemption Area

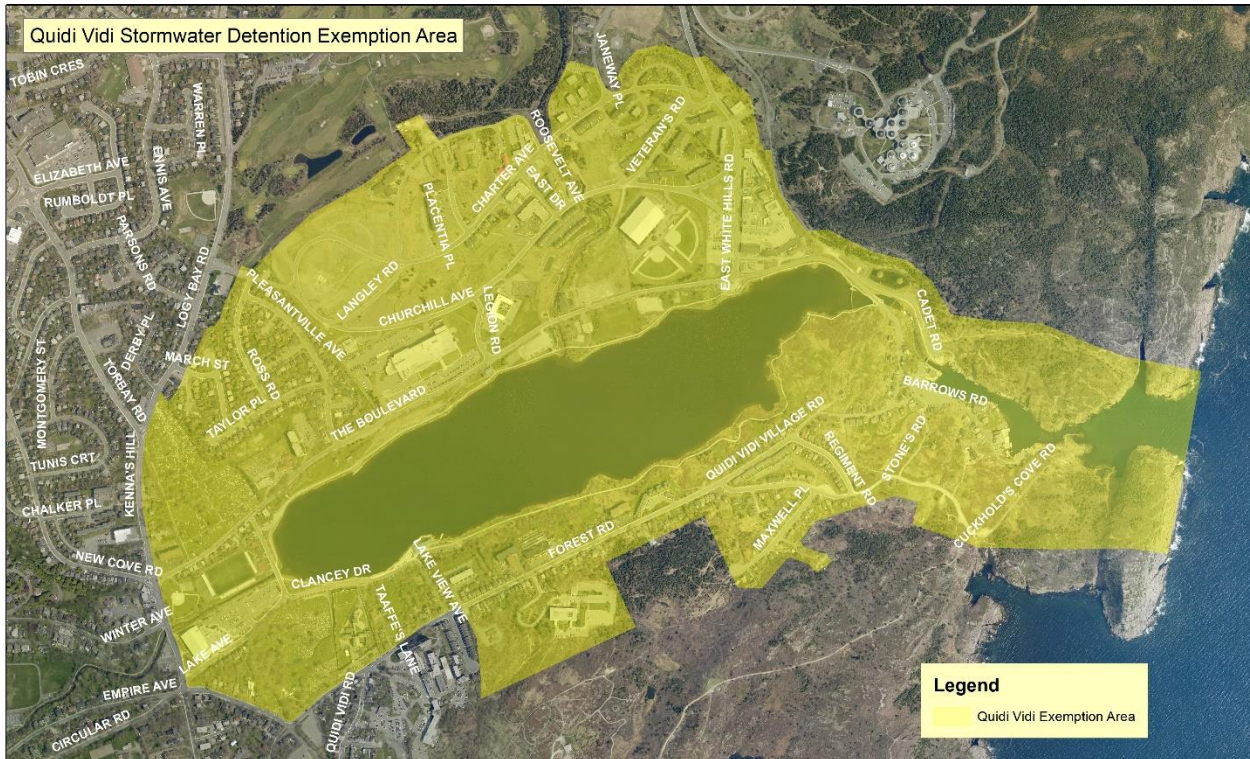

Figure 6-8 - Quidi Vidi Stormwater Detention Exemption Area

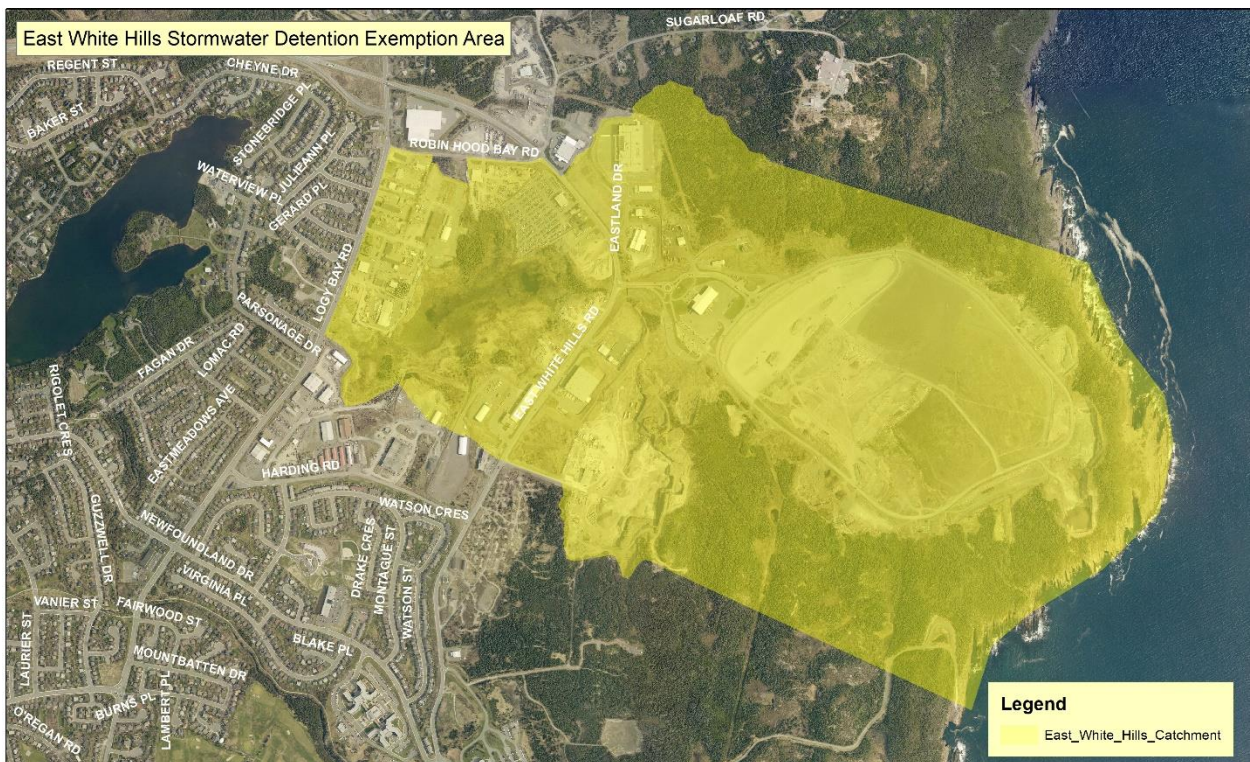

Figure 6-9- East White Hills Stormwater Detention Exemption Area

Stormwater detention facilities receive stormwater runoff primarily from conveyance systems (eg. ditches, roads, storm sewers) and discharge at or less than pre-development flow rates to receiving waters or to existing storm sewer systems. All stormwater detention facilities require the appropriate approvals from the City of St. John's, the Provincial Department of Environment and Climate Change, and the Federal Department of Fisheries and Oceans.

Stormwater detention facilities must be designed to provide adequate flood protection (storage volume for quantity control). All stormwater facilities shall be designed to provide active storage for the 100-year return period event.

Overland and underground drainage routes that direct flows from the design storm event to the storage detention facility must be provided.

An emergency overland escape route from all storage detention facilities shall be provided. In general, the escape route shall provide a minimum capacity between 1 and 2 cubic meters per second. Appropriate capacity shall be determined at the time of design.

Sanitary sewer manholes must be located outside of the impoundment (pond) areas. Sanitary sewer manholes shall not be located within the overland drainage route.

6.4.1 WET PONDS

Wet ponds are impoundment areas used to temporarily store stormwater runoff in order to: promote settlement of runoff pollutants, restrict downstream discharge to or below pre-development levels, to minimize downstream flooding and reduce erosion potential. Wet ponds are similar to lakes and ponds in the St. John's area in that there is a permanent body of water. During runoff events, additional temporary storage is provided above the Permanent Water Level (PWL). After the runoff event, the water level gradually recedes back to its original pond level. Wet ponds may be constructed by an embankment or through excavation of a depression. Design of the facility includes the upper stage (above PWL), where the volume from runoff events is stored, and the lower stage (below PWL), where sedimentation is promoted. It is the lower stage that provides the pond's primary source of water quality enhancement. Sediment forebays may be required on all wet ponds to help confine settlement for larger pollutant particles.

6.4.1.1 VOLUMETRIC SIZING

Wet ponds shall provide an active storage volume for the 100-year event as calculated in Section 6.1.

- I. As a minimum, the permanent pool (pond bottom to PWL) must be sized for a volume equal to the 2-year runoff generated by the entire contributing drainage area with full development of the proposed site. The aquatic bench must have a

maximum 7H:1V side-slope while areas of the pond deeper than 0.5m must have a maximum 4H:1V slope.

- II. As a minimum, active storage [PWL to High Water Level (HWL)] must be sized for a volume equal to the 100-year runoff generated by the entire contributing drainage area with full development of the proposed site. Slopes above the PWL must be 4H:1V maximum. The 100-year volume shall be contained before spillover is permitted.

Wet ponds in Commercial developments may have steeper side slopes, but no greater than 2H:1V. In these instances, access to the pond must be restricted with a 8ft high fence with lockable gate. Furthermore, all wet ponds shall have a 4m wide access road extending the full circumference of the pond to accommodate maintenance vehicles.

Release rates from the ponds are restricted to the downstream limiting capacity.

6.4.1.2 LAND DEDICATION

Wet ponds that will be conveyed to the City shall be located on land which is owned by the City or on land which will be conveyed to the City as a condition of approval for the Development.

The maximum level of inundation, the HWL, must not encroach onto private property. Lots bordering the wet pond are required to have abutting property elevations a minimum of 0.3m above the spillover elevation of the pond and basement elevations must be 0.3m above the HWL.

6.4.1.3 DRAINAGE AREA

Wet Ponds shall have a minimum 5 hectare contributing drainage area. A geotechnical report will be required to determine whether or not the bottom and sides of the wet pond shall be lined with an impermeable geomembrane. In general, the seasonal high groundwater elevation shall be 1m below the lowest elevation of the wet pond, otherwise a geomembrane will be required. Geomembranes need to be adequately anchored to avoid hydrostatic uplift.

6.4.1.4 WINTER OPERATION

During the winter, ice cover will reduce the design volume of the permanent pool. To compensate for the loss of volume due to ice cover a 1-meter freeboard must be constructed between the HWL and the emergency spillway. Precautions shall be taken to minimize the effects of freezing of pipes and outlet control devices.

6.4.1.5 CIRCULATION

Narrow and/or dead bay areas are not permitted. Inlets and outlets shall be located to maximize detention time and circulation, and to reduce short-circuiting through the pond.

6.4.1.6 SEDIMENT FOREBAY

A sediment forebay facilitates maintenance and improves sediment removal of larger particles near the inlet of the pond. The forebay shall be one of the deeper areas of the pond to minimize the potential for particle re-suspension. The forebay can be included within the wet pond area or as a separate facility. Each inlet location must have a sediment forebay.

6.4.1.6.1 *Forebay Length*

Sizing of the forebay depends on the inlet configuration. There are several calculations that need to be made to ensure that it is adequately sized. In all cases, the forebay length shall be greater than, or equal to, the larger of the two forebay lengths determined below by Equations (6.26) and (6.27).

Forebay Length Using Settling Calculations

The primary method to calculate forebay volume and length must be based on settling calculations. The calculations determine the distance required to settle out a certain size of sediment. It is assumed that the flow out of the pond dictates the velocity through the forebay and the rest of the pond. Although this is not entirely correct, it is reasonable for the determination of an appropriate forebay length. Equation (6.35) defines the appropriate forebay length for a given settling velocity and hence particle size to be trapped in the forebay.

$$L = \sqrt{\frac{rQ_p}{V_s}} \quad (6.35)$$

Where:

L = Forebay length, in meters

r = Length-to-width ratio of forebay

Q_p = Peak flow rate from pond, in cubic meters per second

V_s = Settling velocity = 0.0003 meters per second

In all instances the forebay shall not exceed one-third of the pond surface area. As well, the length-to-width ratio in the forebay shall be 2:1.

Forebay Length Using Dispersion Calculations

The dispersion refers to the length of fluid required to slow a jet discharge, such as pipe flow. Equation (6.36) provides a simple guideline for the length of the forebay required to dissipate flows from the inlet pipe. It is recommended that the forebay length is such that a fluid jet will disperse to a velocity of 0.5 m/s (discharge jet) at the forebay berm.

$$L = \frac{8Q}{dV_f} \quad (6.36)$$

Where:

L = Forebay length, in meters

Q = Inlet flow rate, in cubic meters per second

d = Depth of permanent forebay pool, in meters - Maximum depth = 2.4m

V_f = Desired forebay velocity = 0.5 m/s

6.4.1.6.2 Forebay Width

The minimum bottom width of the deep zone in the forebay is given by Equation (6.37).

$$Width_{bottom} = \frac{L}{8} \quad (6.37)$$

The bottom forebay width is calculated using the largest length derived from Equations (6.26) and (6.27).

6.4.1.6.3 Forebay Depth

The minimum depth of the sediment forebay shall be 1.5 m and the maximum depth shall be 2.4m.

6.4.1.6.4 Forebay Length-to-Width Ratio

The total length of the forebay shall provide a length to width ratio 2:1 for each inlet. A length to width ratio < 2:1 is undesirable since the storage will not be utilized effectively. In this case, the addition of flow baffles, or other means of lengthening the flow path in the forebay, may be used, subject to approval by the PERS. When lengthening methods are used, effective length is measured along the flow path.

6.4.1.7 FOREBAY BERM

An earthen berm shall be used to separate the forebay from the rest of the pond. The top of the berm shall be submerged slightly, 0.15 m to 0.3 m below the Normal Water

Level (NWL). A submerged berm provides a safety benefit to the public (provides a barrier to the public walking along the berm) and allows vegetation to be planted around and along the berm. The berm shall be constructed with a solid substrate to facilitate removal of accumulated sediment and debris.

Emergent vegetation shall be planted along the berm to promote filtration of water as it passes over. The plants shall be established on the top and sides of the berm at a maximum planting depth of 30 cm.

Although not required, pipes may be installed in the berm to serve as the primary conveyance system from the forebay to the pond, or as a secondary conveyance system to supplement flows over the submerged berm. Flow calculations shall be made to ensure the berm does not create a flow restriction, causing the forebay to overflow under design conditions.

The invert of any conveyance pipes installed in the berm shall be set at least 0.6 m above the bottom of the forebay to prevent siphoning of settled material into the rest of the pond. A maintenance pipe with gate valve shall also be installed in the berm to allow drawdown of the forebay during maintenance. If only the forebay is to be pumped out or drawn down during maintenance, the forebay berm must be designed as a small dam since the rest of the pond will not be drained. Care must be taken not to compromise the structural integrity of the berm or any liners during drawdown conditions.

6.4.1.8 WET POND LENGTH-TO-WIDTH RATIO

The overall performance of the pond is influenced by the flow path through the pond. Problems encountered with other Municipality's pond designs include construction of the outlet too close to the inlet and having multiple inlets at opposing ends of the pond based on servicing convenience. In both cases, short-circuiting reduces the effective volume of the facility. Where possible, all stormwater servicing shall be conveyed to one inlet location. To provide the longest flow path through the pond, the inlet shall be located as far away from the outlet as possible. A pond with a minimum length to width ratio of 3:1 will generally have an acceptable flow path. The preferred length to width ratio ranges from 4:1 to 5:1, a ratio outside of this range requires the approval of the PERS. Effective length excludes forebay length.

The provision of additional berms or flow baffles in the pond to redirect flows and lengthen the flow path is also acceptable to ensure short-circuiting will not occur.

6.4.1.9 WET POND DEPTH

The depths of the permanent and active storage areas are based on a variety of criteria, including potential stratification, the tolerance of plants to fluctuating water levels, and safety.

Permanent Storage Area

The minimum depth from the pond bottom to PWL shall be 1.5 m. A total maximum depth of 2.4 m shall not be exceeded.

Active Storage Area

The maximum active storage depth shall be 0.9 m. The active storage depth is defined as the depth between PWL and HWL. In addition, a minimum freeboard of 0.3 m is required above HWL.

6.4.1.10 HYDRAULICS

The 100-year elevation shall be established taking into consideration the adjacent building's footing elevations. When the wet pond is at the 100-year elevation, water shall not back up through the storm sewer and weeping tile connections to create hydraulic pressure on foundations. Areas affected by the HWL and resulting hydraulic grade line shall be kept to a minimum. Free flow conditions are preferable; this is achieved when the crown of the closest incoming storm sewer(s) is at or above the HWL. All hydraulic conditions must be approved by PERS.

When free flow conditions are not achieved based on the HWL, hydraulic grade line (HGL) elevations in the storm sewers must be determined based on the pond at HWL and the appropriate losses taken into account (i.e., junction losses, pipe losses, etc.). Surrounding footing (or slab) elevations must be a minimum of 0.3 m above the HGL. Other options to protecting weeping tile connections include a separate weeping tile system connected downstream of the pond. Weeping tile connected to a sanitary sewer is not permitted in any circumstances.

Surcharging is not permitted. Backflow prevention devices are required on all weeping tile connections as per the National Building Code. All upstream storm piping below the HWL and HGL must be rubber gasketed.

6.4.1.11 LANDSCAPING & VEGETATION

Landscaping and vegetation plans must be submitted with the engineered drawings. The drawings must be reviewed and approved by PERS and Public Works. All landscaping must be prepared by a qualified Landscaping Consultant and must conform to the approved plant species list in Section 9. A holistic planting strategy is required to provide aesthetics, safety, enhanced pollutant removal, waterfowl (unwanted) control, potential recreation amenity, and enhanced biological activity within the pond (the purpose of the planting is to provide a sustainable community with a naturalization treatment). In this light, the 'wet pond' is not merely a man-made water storage device, it is a hydrodynamic (vertically fluctuating) biological system that functions most efficiently when all systems work in concert with one another. Obligatory for the creation of a 'biological system', is the need for appropriate plant material. For the City of St.

John's, plant species native to the Avalon Peninsula shall be used. Planting density is to be determined based on individual site characteristics and to promote natural succession. As well, the overall planting shall be designed to minimize maintenance following the establishment period. Manicured and mown areas shall be kept to a minimum, as these areas can attract unwanted waterfowl and become a problem.

6.4.1.12 VEGETATION GRADIENTS

Vegetation gradients refer to vegetation transitions found along the vertical axis of any sized drainage basin; whether it is regional or site scale. When referring to a wet pond system with characteristic fluctuating water levels, vegetation gradients can be in flux during a prolonged establishment period due in part to a cycle of sediment deposition, re-suspension, and subsequent deposition. The significance of this is the need for consideration when designing vegetation gradients. With most natural wet pond systems, there is constant vegetation gradient fluctuation, typically with ample horizontal space. This in mind, the difference between a true wet pond and the wet pond systems proposed is that the horizontal space is fixed. Design implications of this include the need for wet pond wall slopes to accommodate not only safety aspects but, as well, fixed spatial sediment deposition cycles, and the need to facilitate changing vegetation gradients. The design of variable vegetation gradients necessitates the need to provide adequate overlap of vegetation types.

This Manual defines five hydrologic/vegetation gradients present within a wet pond: i). Deep Water areas; ii). Shallow Water areas; iii). Shoreline Fringe areas; iv). Flood Fringe areas; and v). Upland areas. The following describes the conditions present in each and introduces vegetation types applicable for each.

Deep Water Areas

The majority of an area in a wet pond is comprised of deep water areas. Plantings in deep water areas are restricted to *aquatic* and *submergent vegetation*. The transition between shallow and deep water plantings will eventually establish itself according to water level fluctuations, sediment deposition cycles, and light availability.

Shallow Water Areas

Shallow water areas, the aquatic bench, are considered to be the areas of the permanent pool where the depth is 0.5 m or less. This is typically defined as the perimeter of the pond. Plantings in shallow water areas include both *submergent* and *emergent vegetation*. *Submergent* plant species shall be planted at water depths between 0.3 m and 0.5 m. *Emergent* plant species shall be planted at water depths at 0.3 meters. The wet pond wall side slopes will determine the amount of vegetation that can be established. The selection of plant species shall consider nutrient uptake (for absorbing excess nitrates conveyed with first-flush stormwater), stormwater filtration, safety, and aesthetics. Other benefits of *emergent* vegetation include the prevention of

re-suspension of bottom sediments and the reduction of flow velocities to aid in sedimentation.

Shoreline Fringe Areas

Shoreline fringe areas are the areas subject to frequent wetting from storm events. In general, this is the gradient delineated between the PWL and HWL for erosion/water quality control. This area will typically have higher soil moisture conditions during the frequent storm events. The area close to the NWL (normal water level) elevation is subject to more frequent flooding and wave action from the pond. This area must be adequately protected from erosion. Plantings in shoreline fringe areas include both *emergent* and *hydric vegetation*. Due to the frequency of inundation, plant stocks shall be used instead of seed.

Flood Fringe Areas

When the wet pond is used to control peak flow rates, a zone of infrequent inundation is created. This gradient is referred to as the flood fringe area and is generally the area slightly below or above the HWL (high water level). Plantings in the flood fringe area include transitional *hydric* species and a mix of grass, perennial, and shrub species. In addition, deterrent vegetation (species which discourage access either by species characteristics and/or density) may be planted to provide safety measures as an alternative to fencing. Together with upland plantings, an effective barrier to public entry can be obtained.

Upland Areas

Upland areas are landscaped areas above the HWL (high water level) that provide aesthetic and passive recreation amenities around the pond. Plant species shall be chosen to restrict access to steep areas or inlet/outlet locations.

A minimum horizontal buffer strip of 5 meters shall be provided between the HWL and the property line, or a 15 meter horizontal buffer strip between NWL and the property line, whichever is greater. Any formal pathways to be incorporated must be constructed above the 100-year elevation (HWL). Pathway locations and design shall also consider the protection of any native habitats created or protected. Any deviations require approval of PERS.

6.4.1.13 INLET STRUCTURE

Inlet areas and inlet structures must be designed to control design velocities. Because of concerns for winter operation, the minimum diameter of inlet pipes must be 450mm with a pipe slope equal to or greater than 1%. The stormwater conveyance system from the Development must have one discharge location into the detention pond. Rock lined channels which convey stormwater from the pipe outlet to the pond will not be approved as they promote water temperature increases. A hard-bottomed surface (eg.

interlocking stone) near the outfall for the inlet pipe is required to ensure that erosion and scour of the pond bottom do not occur. A non-submerged inlet pipe is generally preferred over submerged inlets. Where a submerged inlet is required, its obvert must be located 150mm below the expected maximum ice depth. The headwalls and wingwalls at inlets shall be constructed of natural stone and plant material to blend in better with the natural landscape. Access to the inlet area must be provided to facilitate maintenance and repairs.

6.4.1.14 OUTLET STRUCTURE

Outlet control structures vary greatly in design and to a certain degree can be site specific. In general, they can be modeled as orifices and/or weirs and the optimum design must meet the flood-control objectives. One possible configuration is a manhole structure built into a dike or berm with low to medium flows controlled by an orifice and weir, and high flows handled by a “ditch inlet type” opening. A trash rack type screen is mounted over the orifice to minimize the size of objects/obstructions entering the structure and the rack is designed to be raised and lowered for easy maintenance. A second alternative for an outlet structure could be a reverse sloped pipe to control the permanent pool elevation where a maintenance pipe is provided for draining the pond during maintenance. The maintenance pipe shall be sized to drain the pond in 6 hours subject to this release rate not impacting on the downstream system.

Submerged outlets must be set 150mm below the expected maximum ice depth. Reversed sloped pipes must have a minimum 300mm diameter. The emergency spillway must be sized to accommodate the 100-year design criteria and flows must be conveyed through an appropriately sized conduit to the nearest watercourse.

Access to the outlet area must be provided to facilitate maintenance and repairs.

6.4.2 ENGINEERED WETLAND

Wetlands are a group of land areas which are referred to as bogs, fens, marshes, swamps, or shallow water. Engineered wetlands are man-made systems that have been designed to mimic the natural storage and treatment processes of wetland ecosystems. The type of wetland considered in this design Manual is the free water surface wetland which is similar to a natural marsh.

In many cases the design elements for wetlands are the same as for wet ponds. In such cases, the reader is referred to Section 6.4.1. Figure 6-10 illustrates an engineered wetland with inlet and outlet headwalls, sediment forebay, a meandering low flow channel, and berming.

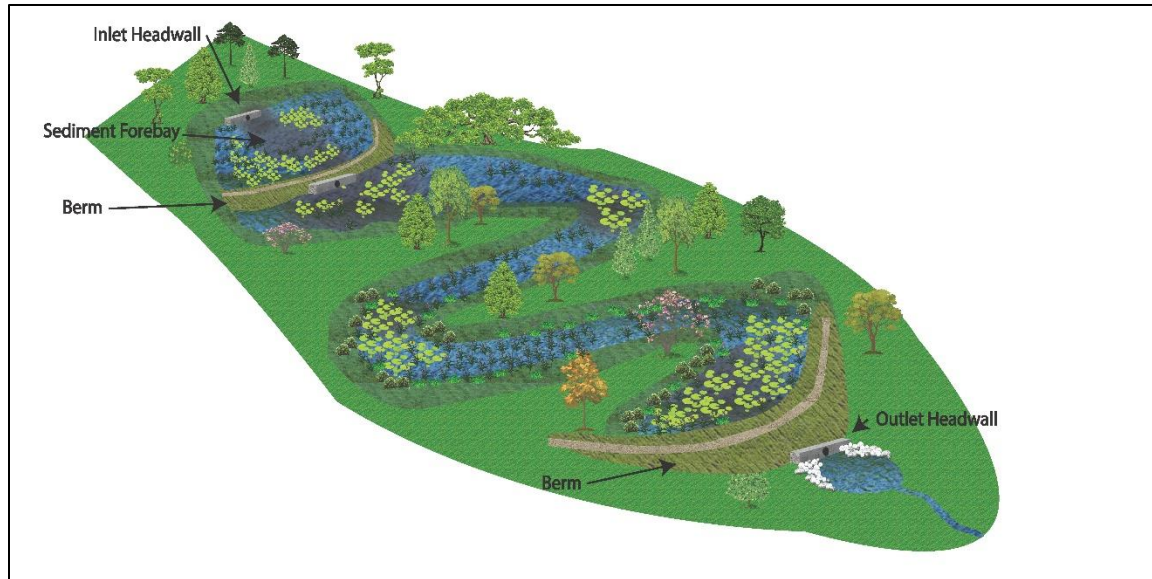

Figure 6-10 - Engineered Wetland

6.4.2.1 DRAINAGE AREA

Wetlands require a minimum drainage area to sustain the aquatic vegetation and the permanent pool. Wetlands shall only be implemented for drainage areas equal to or greater than 5 hectares. Smaller drainage areas may be permitted where it can be demonstrated through a geotechnical report that there is a high groundwater table throughout the majority of a given year.

6.4.2.2 VOLUMETRIC SIZING

The required volume of the engineered wetland will be calculated based on Section 6.1.

6.4.2.3 SEDIMENT FOREBAY

Sediment forebays, see Figure 6-11, in wetland design restrict sedimentation to the forebay area and minimize wetland vegetation disturbance during maintenance operations. The sediment forebay shall be sized in accordance with Section 6.4.1.6 and the following sections.



Figure 6-11 - Sediment Forebay

6.4.2.4 WETLAND LENGTH-TO-WIDTH RATIO

The flow path through a wetland is important overall wetland performance. The flow path in a wetland is mostly dependent on the plantings and grading within the wetland due to the shallow depth of the permanent pool. A length-to-width ratio of 3:1 is required in engineered wetlands and it shall be measured based on the flow path of low flows through the wetland rather than the overall dimensions of the wetland. Low flow paths shall be created through the wetland to ensure that short-circuiting does not occur and that the flow path through the wetland is maximized during small events. Figure 6-10 illustrates the concept of maximizing the length using a meandering low flow path.

6.4.2.5 PERMANENT POOL AND ACTIVE STORAGE DEPTHS

The average permanent pool depth in a wetland shall range between 150 mm to 300 mm. Inlet and outlet areas shall be a minimum 1.0 meter deep to reduce re-suspension and discharge of settled pollutants. The maximum permanent pool depths in the inlet and outlet areas shall be restricted to 1.5 meters. The maximum active storage depth shall be 0.9 meters. This ensures that the maximum overall depth in the wetland during an extreme event will not exceed 2.4 meters.

6.4.2.6 LANDSCAPING AND VEGETATION

Refer to Section 6.4.1.11.

6.4.2.7 GRADING

Grading in a wetland shall be reasonably flat. The side slopes near the permanent pool shall be 5H:1V or flatter. Terraced grading is recommended to minimize the risk of any person falling into the wetland.

Grading shall be designed to replicate the natural landform with varied slopes. A rolling shoreline is also an effective means to integrate the wetland into the landscape as a feature which is natural in appearance.

6.4.2.8 INLET CONFIGURATION

The stormwater conveyance system (sewers, grassed swales) shall have one discharge location into the wetland. Inlets to wetlands shall be designed to be non-submerged. The invert of the inlet pipe is set at the maximum design water level in the wetland. It is important that any erosion potential between the inlet and the permanent pool be addressed in design. The use of environmental stone/blocks (interlocking blocks with large openings to allow vegetative growth in between the blocks) in this area is recommended since they will minimize the erosion potential.

6.4.2.9 OUTLET CONFIGURATION

The outlet configuration options for a wetland are similar to those for a wet pond. In general, reverse sloped pipe configurations are recommended when the design incorporates a deep pool at the outlet. A perforated pipe riser is appropriate where a deep pool is not provided.

6.4.2.10 WINTER OPERATION

During the winter period, much of a wetland's permanent pool volume will be frozen. The wetland will therefore behave in a manner similar to a dry pond.

6.4.3 DRY PONDS

Dry ponds are impoundment areas used to temporarily store stormwater runoff in order to restrict downstream discharge to predetermined rates, and to reduce downstream flooding and erosion potential. They may be constructed by an embankment or through excavation of a depression. Most dry ponds have no permanent pool of water. As a result, they can be effectively used for quantity control. Water quality enhancement may be required through the use of sediment forebays that include a permanent pool. Dry ponds may be constructed where topographic or planning constraints exist that limit the implementation of wet ponds or wetlands.

6.4.3.1 VOLUMETRIC SIZING

Dry ponds must provide an active storage volume for the 100-year event. As a minimum, the active storage must be sized for a volume equal to the 100-year runoff generated by the entire contributing drainage area with full development of the proposed site. All side-slopes shall be 4H:1V or flatter. The 100-year volume shall be contained before overtopping can occur. Release rates from the ponds must be, as a minimum, restricted to downstream limiting capacity of the receiving system.

Dry ponds in Commercial developments may have steeper side slopes, but no greater than 2H:1V. In these instances, access to the pond must be restricted with a 8ft high fence with lockable gate. Furthermore, all dry ponds shall have a 4m wide access road extending the full circumference of the pond to accommodate maintenance vehicles.

6.4.3.2 LAND DEDICATION

Dry ponds that are to be ultimately operated by the City shall be located on land to be conveyed to the City as a condition of approval for the Development, or on City owned land at the City's sole discretion.

The maximum level of inundation, the High Water Level (HWL), must not encroach onto private property. Lots bordering the dry pond are required to have abutting property elevations a minimum of 0.3 m above the spillover elevation of the pond and basement elevations must be 0.3 m above the HWL and the hydraulic grade line.

6.4.3.3 DRAINAGE AREA

There is no minimum drainage area requirement for dry ponds.

An impermeable geomembrane may be required if deemed necessary by PERS staff.

6.4.3.4 LOW FLOW CHANNEL

A low flow channel shall be constructed through the pond, suitable vegetation along the channel must be used and approved by PERS.

6.4.3.5 WINTER OPERATION

Dry ponds are normally the least affected by winter/spring conditions, however, precautions shall be taken to minimize the effects of freezing of pipes and orifices.

6.4.3.6 SEDIMENT FOREBAY

A sediment forebay facilitates maintenance and improves sediment removal of larger particles near the inlet of the pond. Sediment forebays are to be designed and constructed following the methodology in Section 6.4.1.6 and the following Sections.

6.4.3.7 FOREBAY BERMS

An earthen berm shall be used to separate the forebay from the rest of the pond. Since the downstream side of the berm will be dry, the berm shall be designed as a small dam. A weir shall be designed at the top of the berm to convey flows to the downstream section of the pond during storm events. The forebay shall be incorporated as a permanent pool set below the bottom elevation of the dry pond.

To facilitate cleaning of the forebay, a maintenance pipe shall be installed in the berm. A valve, to open and close the pipe, shall be installed on the upstream side of the pipe. Under normal operating conditions, the valve shall be closed. During maintenance periods, the valve can be opened to allow draining of the forebay.

Vegetation must be planted on the top of the berm to promote filtration of water as it passes over the berm. The vegetation shall be planted on the forebay side of the berm at a depth no greater than 30 cm. As a secondary benefit, the vegetation will also act as a barrier to public access.

6.4.3.8 DRY POND LENGTH-TO-WIDTH RATIO

For dry ponds with a continuous flow path, all stormwater shall be conveyed to one inlet location. To provide the longest flow path through the pond, the inlet shall be located as far away from the outlet as possible. A pond with a length-to-width ratio greater than, or equal to, 3:1 will have an acceptable flow path. The preferred length-to-width ratio ranges from 4:1 to 5:1. Effective length excludes forebay length.

6.4.3.9 DRY POND DEPTH

The maximum active depth for a dry pond is 2.1 m, measured from the elevation of the pond bottom to the 100-year elevation (HWL). In addition, a freeboard of 0.3 m is required above the HWL. The maximum active depth from the PWL in the forebay to the 100-year elevation (HWL) must be 0.9 m. The primary factor in establishing these depth restrictions is concern for the safety of children.

6.4.3.10 HYDRAULICS

The 100-year elevation shall be established taking into consideration the adjacent building's footing elevations. When the dry pond is at the 100-year elevation, water shall not back up through the storm sewer and weeping tile connections to create hydraulic pressure on foundations. Areas affected by the HWL and resulting hydraulic grade line shall be kept to a minimum. Free flow conditions are preferable; this is achieved when the crown of the closest incoming storm sewer is at or above the HWL. All hydraulic conditions must be approved by the PERS.

When free flow conditions are not achieved based on the HWL, Hydraulic Grade Line (HGL) elevations in the storm sewers must be determined based on the pond at HWL

and the appropriate losses taken into account (i.e., junction losses, pipe losses, etc.). Surrounding footing (or slab) elevations must be a minimum of 0.3 m above the HGL. Other options to protecting weeping tile connections include a separate weeping tile system connected downstream of the pond. Weeping tile connected to a sanitary sewer is not permitted in any circumstances.

Surcharging will **not** be permitted. Backflow prevention devices are required on all weeping tile connections as per the National Building Code. All upstream storm piping below the HWL and HGL must be rubber gasketed.

6.4.3.11 OUTLET STRUCTURE

Outlet control structures vary greatly in design and to a certain degree can be site specific. In general, they can be pipes, orifices and/or weirs and the optimum design must meet the flood-control objectives. One possible configuration is a riser pipe structure built into an embankment with low flows controlled by riprap-covered intake, and medium to high flows handled perforated riser pipe opening. Other configuration may be considered and shall require the approval of PERS.

6.4.4 UNDERGROUND DETENTION

Underground pipe detention is intended for small Developments which lack sufficient surface area to construct the aboveground detention facilities described in the previous Sections. Underground detention is achieved using: (1) a watertight closed pipe or series of closed pipes; (2) a bottomless pipe or series of bottomless pipes buried in a washed stone media surrounded by an impermeable liner; or (3) a watertight vault or chamber. Each of the aforementioned must be sized to temporarily store the required stormwater detention volume as per Section 6.1.

Underground detention facilities are equipped with a small outlet control device such as a small diameter pipe, orifice, or a weir to limit flow.

6.4.4.1 GENERAL DESIGN REQUIREMENTS

- I. The maximum allowable drain time after a 100-year event is 72 hours.
- II. Overburden dead loads and traffic loading must be considered by the Designer when assessing the structural suitability of the proposed detention facility.
- III. The minimum allowable distance between underground detention and any adjacent property is 3 m.
- IV. Pretreatment must be incorporated into all underground detention designs for all inlets. This can be achieved through the use of sumps or filter strips for overland flow.

- V. Porosity values for storage volume calculations are as follows: soil media (20%), Sand (30%), and washed stone (40%).
- VI. Washed stone must be separated from sand and soil media by a geomembrane which has a 1mm minimum average thickness and conforms to “**City of St. John’s – High Density Polyethylene Geomembrane Specification for Stormwater Detention**”.
- VII. Outlet control devices must be provided to regulate flow in order to meet the required release rate, drain down time, ponding depth and any other requirements.
- VIII. Outlet control devices shall be located for easy access and maintenance.

6.4.4.2 OUTLET CONTROL DEVICES

See Section 6.2.6.

6.4.4.3 SLOPE

Underground stormwater detention pipes and chambers require a flat slope in order to optimize storage. A slope of 0.1% is acceptable for stormwater detention pipes or chambers in order to maximize storage. This assumes an appropriate outlet control device will be provided to limit flows and create the storage.

6.4.4.4 LENGTH, WIDTH AND HEIGHT

The maximum length of an underground detention pipe or chamber shall be 120 m. The maximum height of an underground detention pipe shall be 2.1 m and an underground chamber shall have a maximum height of 2.4 m. The maximum width of an underground detention pipe shall be 2.1 m, maximum chamber width shall be limited to 6 m. If additional capacity is required, then parallel pipes or chambers shall be used.

6.4.4.5 ACCESS

Access hatches must be placed over the upstream and downstream ends of each pipe or chamber for maintenance purposes. Accesses will be required over all inlets, outlets including the outlet control device(s).

6.4.4.6 SURCHARGING

Surcharging in underground pipe or chamber detention is not permitted. The hydraulic grade line within in the detention structure shall be equal to or less than the obvert of the pipe or chamber. It is permissible and necessary to surcharge the outlet control device to the obvert of the pipe or chamber in order to maximize storage.

6.4.4.7 EMERGENCY OVERFLOWS PATH

Emergency surface overflow paths shall be located and sized to convey the 100-year runoff. The emergency overflow path cannot travel over private property and overflow must be directed to a City street or an approved watercourse.

6.4.4.8 LOCATION

Underground detention shall be installed where the facility can be easily excavated for maintenance. Suitable locations include parking lots and green spaces. Underground detention that will be conveyed to the City as a condition of Development cannot be located within the street Right-Of-Way.

6.4.5 PARKING LOT STORAGE

Parking lot surfaces may be used to store some stormwater runoff provided the maximum depth of ponding does not exceed 150 mm. Parking lot storage is applicable to Non-Residential developments and shall not be used in Residential areas.

6.4.5.1 PARKING LOT GRADING

Some stormwater detention can be achieved by surface storage in “bowl” shaped parking lots that drain to a sag catchbasin. Parking lot grades shall range between 0.5% to 4.0% in order create small depressions which can drain by a catchbasin. The catchbasin grate will be the flow control into the storm sewer system.

6.4.5.2 EMERGENCY OVERFLOW

Overflow flow paths shall be designed to a handle any runoff that exceeds the storage capacity of the parking lot surface. Overflow can be directed to other catchbasins within the parking lot or to other onsite stormwater management devices.

6.5 STORMWATER RETENTION

Stormwater retention is achieved through Low Impact Development (LID) techniques which use a soft Engineering approach to manage rainfall on site through a vegetated treatment network. The purpose of LID is to sustain a site’s pre-development hydrologic regime by using techniques that infiltrate, filter, store, and evaporate stormwater runoff at its source. LID also remediates polluted stormwater runoff through a variety of treatment landscapes. Any of the LIDs in this Section can be used for Green Street BMPs.

This Manual provides Developers instruction on how to apply LIDs to new, existing, and redeveloped sites.

6.5.1 MINIMUM LID REQUIREMENTS

For LIDs that use infiltration as a means of controlling stormwater, the following requirements shall be met:

- I. The base (lowest elevation) of the LID structure shall be separated by at least one meter vertically from the seasonal high groundwater elevation;
- II. The base (lowest elevation) of the LID structure shall be separated by at least one meter vertically from bedrock;
- III. LIDs shall not be used for areas having a slope greater than 15%;
- IV. Natural soils at the base of the LID shall have an infiltration rate equal to or greater than 13 millimeters per hour;
- V. LIDs shall not be located closer than 30 m horizontally from any watercourse or water supply well; The base elevation of the LID shall be at least 0.3 m above the 100-year floodplain elevation.
- VI. LIDs shall not be located within a minimum 6 m of a property boundary. Surfaces with steep slopes (> 4H:1V) may require a larger separation from the property boundary.
- VII. LIDs shall be setback a minimum 30 m upgradient and 6 m downgradient from permanent structures and septic fields. In no case shall LIDs be placed in locations that cause water problems to structures or adjacent properties. LIDs shall be setback 6 m from any public Right-Of-Way.

6.5.2 SITE EVALUATION

On-site geotechnical testing is required for the design of all LIDs using infiltration as a means to control stormwater. Testing shall be performed at the (a) Approval-In-Principle stage and (b) at the final design stage. Testing shall be performed in accordance with this Manual and shall be performed by a qualified Engineer or geologist. Testing shall be done during seasonal high groundwater conditions. The minimum testing schedule is indicated in Table 6-10.

Table 6-10 - Testing Requirements for LIDs

TYPE	Approval-In-Principle Testing	Final Design Testing	Limited Infiltration (<13mm/hr)
Bioretention	1 double-ring infiltrometer test per 0.25 hectares of bioretention area	1 double-ring infiltrometer test per 0.10 hectares of bioretention area	Underdrain required
Rain Garden	1 double-ring infiltrometer test per 0.25 hectares of bioretention area	1 double-ring infiltrometer test per 0.10 hectares of bioretention area	Underdrain required
Bioswale and Infiltration Trench	1 soil borehole and 1 cased borehole infiltration test per bioswale/trench	1 soil borehole and 1 cased borehole infiltration test per 15m of proposed bioswale/trench length, and 1 piezometer test per bioswale/trench.	Underdrain required
Soakaway Pit	1 soil borehole and 1 cased borehole infiltration test per pit	1 soil borehole and 1 piezometer test per pit	
Filter Strip	1 double-ring infiltrometer test per 0.25 hectares of filter strip area	1 double-ring infiltrometer test per 0.10 hectares of filter strip area	

Approval-In-Principle testing shall be conducted no further than 30 m from the proposed LID and at a location that is similar in geology and groundwater characteristics. Final design testing shall be performed at the location of the proposed LID. Double-ring infiltrometer testing shall be done in accordance with ASTM D3385.

Soil boreholes shall extend a minimum of 1.2 m below the base elevation of the LID and the soil strata shall be recorded from the ground surface to the full depth of the borehole. Soil samples shall be collected and grain size laboratory analysis performed for soil samples acquired at the base and 1.2 m below the base of the proposed LID. Soil sampling and laboratory testing shall be sufficient to determine particle size characteristics. A capped piezometer (sealed at the ground surface to prevent surface water intrusion) perforated from the base to 1.2 m below the base elevation of the proposed LID shall be placed in at least one borehole location per LID to allow measurement of the seasonal variation in the groundwater elevation at the site. At least three measurements of the groundwater elevation shall be obtained from each piezometer between September 15 and November 15 and elevations reported in meters related to Geodetic mean sea level shall be provided to the City. The proponent shall

also provide the ground elevations for each piezometer along with the NAD83 coordinates for the same.

All testing shall be included in a geotechnical report to be submitted to the City and shall include as a minimum the following: map of boreholes and test locations; description of work methods, tabulated data and graphical displays, field test results and laboratory reports, soil boreholes graphic logs, geological strata, soil descriptions, soil depth, sample locations, groundwater elevation including date and time, and depth to bedrock.

6.5.3 BIORETENTION

Bioretention is a stormwater management technique where runoff is directed to a depression which filters the runoff through vegetation and mulch. The runoff then infiltrates into the ground through a sand and gravel medium.

Where infiltrations rates are below 13 mm/hr a perforated underdrain shall be used to direct some of the infiltrated runoff to a storm sewer. Figure 6-12 shows an example of a bioretention facility adjacent to a parking lot.

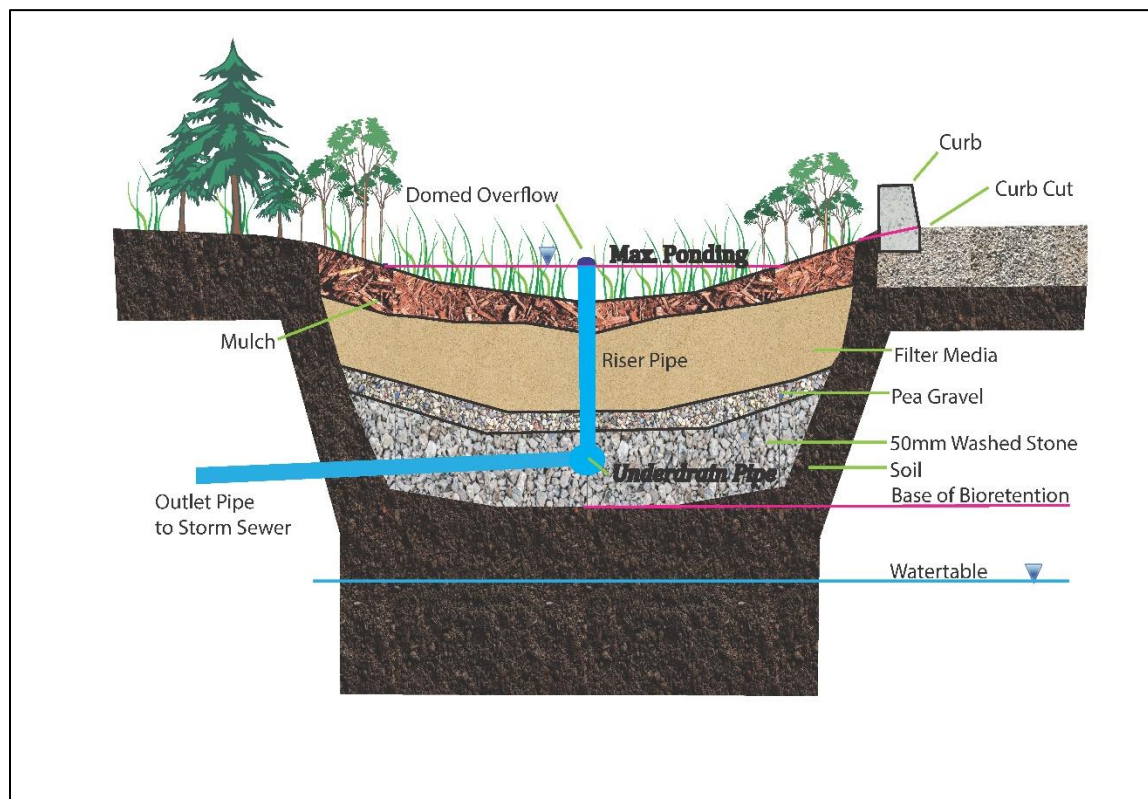

Figure 6-12 - Bioretention

6.5.3.1 APPLICATION

Bioretention facilities are usually located in parking lots, in street Right-Of-Ways, and near rooftop drainage downspouts. They can be utilized for new developments and site redevelopments.

6.5.3.2 INLET

The inlet to the bioretention area shall have a 0.5 m grass filter strip in parking lots.

6.5.3.3 DISCHARGE

The bioretention shall be ideally designed to accommodate the 100-year event. A lesser return period may be used but the Development would require other stormwater management devices in order to capture and retain the 100-year event. The maximum underdrain flow rate shall be limited to the 2-year event.

6.5.3.4 BIORETENTION FACILITY SURFACE AREA

Bioretention filter surface area, A_f , is calculated using Equation (6.38).

$$A_f = \frac{V_Q d_f}{[k(d_w + d_f)t_f]} \quad (6.38)$$

Where:

A_f = Surface area of bioretention filter bed, in square meters

V_Q = Stormwater retention volume, in cubic meters

d_f = Depth of filter bed, in meters

k = Saturated hydraulic conductivity, in meters per day

d_w = Depth of ponding, in meters

t_f = Time to drain, in days

6.5.3.5 MAXIMUM INLET VELOCITY

The velocity in vegetated areas shall be less than 0.5 meters per second to prevent erosion.

6.5.3.6 MAXIMUM BIORETENTION PONDING DEPTH

The maximum ponding depth over the bioretention facility shall be 0.3 meters.

6.5.3.7 CAPTURED VOLUME

The volume of water retained through ponding and infiltration shall be as per Section 6.1.

6.5.3.8 DRAWDOWN

The duration of ponded water over the bioretention facility shall be less than 48 hours.

6.5.3.9 BIORETENTION LAYERS

The surface layer of the bioretention facility shall be 75 mm of mulch. Beneath the mulch shall be a growing media composed of an amended topsoil (infiltration rate 25-50 mm/hr) with a depth of 0.5 m to 1.0 m. Below the growing media shall be a filter layer comprised of pea gravel (<13 mm washed rock with less than 0.1% silt) with a depth of 0.15 m. The lowest layer will be a drainage media (<40 mm washed rock with less than 0.1% silt) with a depth ranging between 0.3 m and 1.0 m.

6.5.3.10 GEOTEXTILE FABRIC

A non-woven needle-punched or woven monofilament geotextile fabric shall be placed around the drainage media layer to control sediment migration. Woven slit film and non-woven heat bonded fabrics shall not be used as they are prone to clogging. Suitable Apparent Opening Sizes (AOS) for non-woven fabrics or percent Open Area (POA) of woven fabrics shall be selected. Table 6-11 and Table 6-12 represent the minimum acceptable requirements for non-woven and woven geotextile fabrics, respectively.

Table 6-11 - Non-Woven Needle-Punched Geotextiles

Specification	ASTM Standard	Minimum Value
Grab Tensile Breaking Load (N)	D4632/D4632M	1112
Grab Tensile Elongation (%)	D4632/D4632M	50
Trapezoidal Tear Strength (N)	D4533/ D4533M	444
CBR Puncture Strength (N)	D6241-14	3114
AOS (mm)	D4751-20b	≤ 0.3
Permittivity (sec ⁻¹)	D4491/ D4491M	0.5
Water Flow (l/min/m ²)	D4491/ D4491M	3000

Table 6-12 - Woven Monofilament Geotextiles

Specification	ASTM Standard	Minimum Value
Grab Tensile Breaking Load (N)	D4632/D4632M	1891/1402
Grab Tensile Elongation (%)	D4632/D4632M	21/21
Trapezoidal Tear Strength (N)	D4533/ D4533M	645/556
CBR Puncture Strength (N)	D6241-14	5963
POA (%)		4
Permittivity (sec ⁻¹)	D4491/ D4491M	0.5
Water Flow (l/min/m ²)	D4491/ D4491M	3000

Note: (1) the hydraulic conductivity (k) of the geotextile, be it woven or non-woven, must be greater than the hydraulic conductivity of the existing soil. (2) the permittivity = $k_{\text{fabric}} / \text{thickness}_{\text{fabric}}$.

6.5.3.11 PERFORATED UNDERDRAIN PIPE

The diameter of the perforated underdrain pipe shall be 200 mm.

6.5.3.12 GEOMETRY

The bottom of the bioretention facility shall be flat and the facility shall have a 2:1 length to width ratio. The side slopes of the vegetated area shall be 4H:1V or flatter.

6.5.3.13 GROUNDWATER DEPTH

The seasonal high groundwater elevation shall be 2.0 m below the bioretention facility finished grade and the base of the facility shall be 1.0 m above the seasonal high groundwater elevation.

6.5.3.14 VEGETATION

Vegetation for bioretention planting shall be submergent and hydric species noted in Division 9.

6.5.3.15 BIORETENTION EXAMPLE COMPUTATION

Example 6.5.3

A Commercial Neighbourhood Development has an overall area of 0.7 hectares, an overland flow path length of 120 meters, and an average slope of 0.0200 meter per meter. Design a bioretention system that will infiltrate all runoff into the ground. A geotechnical report indicates the soil is a sandy gravel with less than 5% silt content, the seasonal high water table is 2.5m below existing ground, and the measured saturated hydraulic conductivity is 0.00097cm/s (0.84m/day).

Procedure 6.5.3

STEP 1: Calculate the 100-year post-development runoff and volume using Equations (6.1) and (6.2).

$$Q_{100} = 0.05319 + 0.55303(0.7) - 0.00094(120) + 3.44885(0.0200) = 0.4 \text{ cms}$$

$$V_Q = 1000 * 0.4 = 400 \text{ m}^3$$

STEP 2: Calculate the surface area of bioretention facility assuming a filter bed depth of 2m, maximum ponding of 0.2m, and a maximum 2 day drain time for the filter bed.

$$A_f = \frac{V_Q d_f}{[k(d_w + d_f)t_f]} = \frac{400 * 2}{0.84(0.2 + 2)2} = 216 \text{ m}^2$$

Results 6.5.3

The bioretention area would need a surface area of 216 m² or an area measuring approximately 10.4m by 20.8m.

6.5.4 INFILTRATION TRENCHES

Infiltration trenches provide storage retention by directing surface water into the ground through infiltration. They are composed of a 40 mm washed stone storage media wrapped in a geotextile fabric. Infiltration trenches are applicable for stormwater drainage areas less than 2 hectares.

Design Criteria:

The volume of the infiltration trench shall be sufficiently sized to allow drainage within a maximum of 48 hours.

6.5.4.1 APPLICATION

Infiltration trenches are primarily used for Residential and Commercial developments. They may be inappropriate for Industrial since there is a high probability for spills and groundwater contamination. Infiltration trenches can be utilized for new developments and site redevelopments.

6.5.4.2 INLET

The inlet to an infiltration trench shall have a 0.5 m grass filter strip.

6.5.4.3 DISCHARGE

Infiltration trenches shall ideally be designed to accommodate the 100-year event. A lesser return period may be used but the Development would require other stormwater management devices in order to capture and retain the 100-year event. The maximum underdrain flow rate shall be limited to the 2-year event.

6.5.4.4 INFILTRATION TRENCH SURFACE AREA

The surface area of the infiltration trench shall be sized based on Equation (6.39).

$$A_i = \frac{1000V_Q}{knt_f} \quad (6.39)$$

Where,

A_i = Surface area of infiltration trench at finished grade, in square meters

V_Q = Stormwater retention volume, in cubic meters

k = Saturated hydraulic conductivity, in millimeters per hour
n = Porosity of storage medium (0.4 for 40 mm washed stone)
t_r = Time to drain, in hours (24 to 48 hours)

6.5.4.5 MAXIMUM INFILTRATION TRENCH PONDING DEPTH

The maximum ponding depth over the Infiltration trench shall be 0.3 m.

6.5.4.6 CAPTURED VOLUME

The volume of water retained through ponding and infiltration shall be as per Section 6.1.

6.5.4.7 DRAWDOWN

The infiltration trench shall fully drain in 48 hours or less.

6.5.4.8 INFILTRATION TRENCH LAYERS

The infiltration trench shall be composed of a drainage media (<40 mm washed rock with less than 0.1% silt) with a depth ranging between 1.0 m and 3.0 m. The drainage media shall extend from the bottom of the trench to finished grade.

6.5.4.9 GEOTEXTILE FABRIC

A non-woven needle-punched or woven monofilament geotextile fabric shall be placed around the sides and bottom of the drainage media layer to control sediment migration. Woven slit film and non-woven heat bonded fabrics shall not be used as they are prone to clogging. Suitable Apparent Opening Sizes (AOS) for non-woven fabrics or percent Open Area (POA) of woven fabrics shall be selected. Table 6-11 and Table 6-12 represent the minimum acceptable requirements for non-woven and woven geotextile fabrics, respectively. Note: (1) the hydraulic conductivity (k) of the geotextile must be greater than the hydraulic conductivity of the existing soil. (2) the permittivity = $k_{\text{fabric}} / \text{thickness}_{\text{fabric}}$.

6.5.4.10 PERFORATED UNDERDRAIN PIPE

If an underdrain is required then the diameter of the perforated underdrain pipe shall be 200 mm.

6.5.4.11 GEOMETRY

The bottom of the infiltration trench shall be flat and the facility shall have a 2:1 length to width ratio.

6.5.4.12 GROUNDWATER DEPTH

The seasonal high groundwater elevation shall be 2.0 m below the bioretention facility finished grade and the base of the facility shall be 1.0 m above the seasonal high groundwater elevation.

6.5.5 BIOSWALE

Grassed swales can be used to store and infiltrate runoff from small areas. Plantings in vegetated swales can reduce velocities, prevent erosion, and filter sedimentation and stormwater pollution. A successfully designed swale is dependent on longitudinal slope and contact area. For example: steep, narrow channels are less effective than flat, wide swales. The design must also be balanced with safety concerns such as swale depth and velocities. There are two types of swales: (a) dry swales; and (b) bio-swales. The latter allows stormwater to infiltrate into a porous, subsurface media with a subdrain pipe, see Figure 6-13.

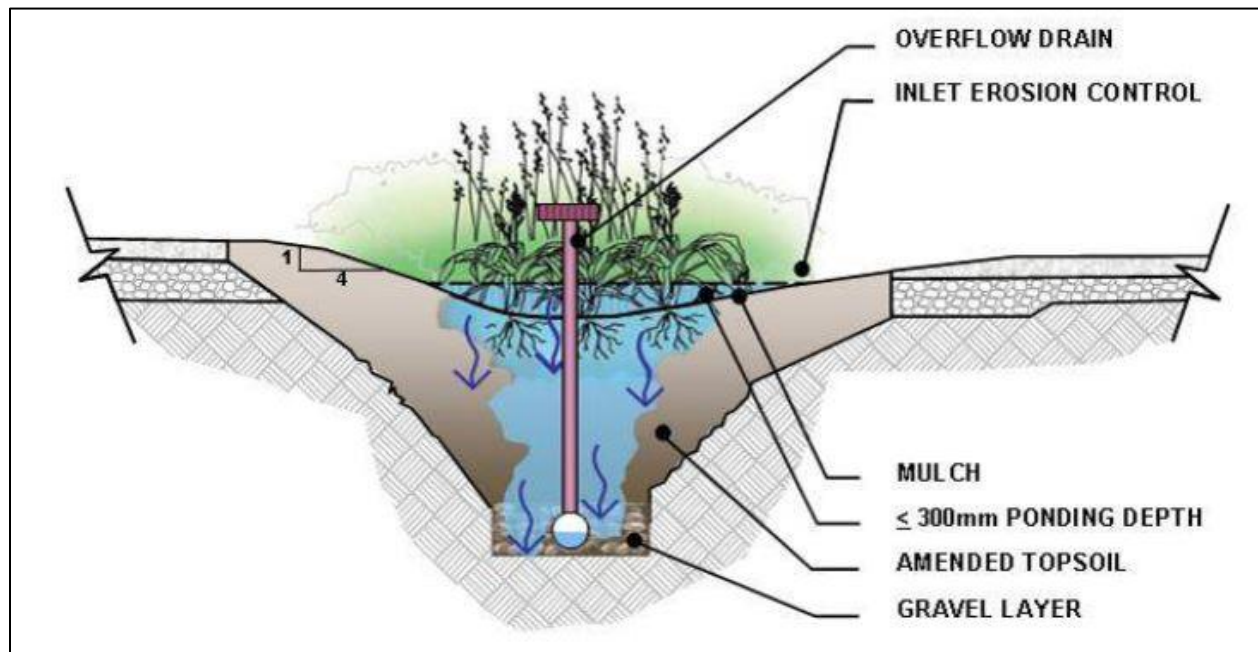

Figure 6-13 - Bioswale

Design Criteria:

- I. To promote infiltration, vegetated swales shall be designed with slopes between 0.5% and 2.0% while providing the appropriate conveyance.
- II. When slopes exceed 2.0% then check dams shall be used to assist storage and infiltration. Peak velocities shall not exceed 1.0 m/s for the 100-year event.
- III. In some designs, a perforated pipe beneath the swale will be required to ensure the required infiltration is achieved.

- IV. A swale shall have the following geometrics: minimum bottom width = 0.5 m; minimum depth = 0.5 m; maximum depth = 1.2 m; side slopes shall be no steeper than 2:1 and where possible side slopes shall be 4H:1V.
- V. Grass shall be local field sods or nursery sods when a more manicured appearance is necessary. The minimum height of grass shall be 75 mm for filtration purposes.

6.5.5.1 APPLICATION

Bioswales are used in Residential and Non-Residential developments, in parking areas, within street Right-Of-Ways, parks, and other areas.

6.5.5.2 INLET

The inlet to the bioswale shall have a minimum 2.0 m grass filter strip.

6.5.5.3 DISCHARGE

Bioswales shall ideally be designed to accommodate the 100-year event. A lesser return period may be used but the Development would require other stormwater management devices in order to capture and retain the 100-year event. The maximum underdrain flow rate shall be limited to the 2-year event.

6.5.5.4 OVERLAND FLOW VELOCITY

Ensure that velocities remain non-erosive for the proposed vegetated surface.

6.5.5.5 MAXIMUM DEPTH

The maximum depth of a bioswale shall be 0.5 m. For the 100-year event, the maximum flow depth shall be 0.3 m or less.

6.5.5.6 MEDIA LAYERS

The upper portion (growing media) of a bioswale shall be 0.3 m in depth and be composed of an amended topsoil. A 0.15 m deep filter media (<13 mm washed stone with <0.1% silt) shall be placed immediately below the growing media. Immediately below the filter media shall be a storage layer (<40 mm washed stone with <0.1% silt) 0.5 m to 1.0 m deep.

6.5.5.7 UNDERDRAIN

The diameter of the perforated underdrain pipe shall be 200 mm.

6.5.5.8 VEGETATION

Grasses and dense vegetation shall be established on slopes of 0.5% to 1.0%. Slopes greater than 1.0% shall have turf grass only with check dams.

6.5.5.9 COMPUTATIONS

Computations shall be provided for the 100-year runoff, volume, capacity of swale, and capacity of retention facility.

6.5.5.10 DRAWDOWN

The bioswale shall fully drain in 24 hours or less.

6.5.5.11 BIOSWALE LAYERS

The bioswale shall be composed of a drainage media (<40mm washed rock with less than 0.1% silt) with a depth ranging between 1.0 meters and 2.0 meters. The drainage media shall extend from the bottom of the trench to finished grade.

6.5.5.12 GEOTEXTILE FABRIC

A non-woven needle-punched or woven monofilament geotextile fabric shall be placed around the top, sides and bottom of the drainage media layer to control sediment migration. Woven slit film and non-woven heat bonded fabrics shall not be used as they are prone to clogging. Suitable Apparent Opening Sizes (AOS) for non-woven fabrics or percent Open Area (POA) of woven fabrics shall be selected. Table 6-11 and Table 6-12 represent the minimum acceptable requirements for non-woven and woven geotextile fabrics, respectively. Note: (1) the hydraulic conductivity (k) of the geotextile, be it woven or non-woven, must be greater than the hydraulic conductivity of the existing soil. (2) the permittivity = $k_{\text{fabric}} / \text{thickness}_{\text{fabric}}$.

6.5.5.13 PERFORATED UNDERDRAIN PIPE

If an underdrain is required then the diameter of the perforated underdrain pipe shall be 200 mm.

6.5.5.14 GEOMETRY

The bioswale shall be trapezoidal or triangular and a cross-section detail shall be included with a design in indicating the geometry, vegetation and retention system.

6.5.5.15 GROUNDWATER DEPTH

The seasonal high groundwater elevation shall be 2.0 m below the bioswale finished grade and the base of the facility shall be 1.0 m above the seasonal high groundwater elevation or bedrock elevation.

6.5.5.16 BIOSWALE SURFACE WIDTH

The bioswale shall have a width ranging between 0.6 m and 3.0 m.

6.5.5.17 BIOSWALE SURFACE SIDE SLOPES

The side slopes of the swale shall be 4H:1V.

6.5.5.18 BIOSWALE LONGITUDINAL SLOPE

Bioswale shall be sufficiently flat to maintain non-erosive velocities for the 100-year runoff. Slopes in excess of 1.0% will require check dams or another acceptable type of grade control structure.

6.5.6 PERMEABLE BRICK PAVEMENTS

Permeable brick pavements (also known as porous pavers or modular pavers) have excellent performance results in cold climates, see Figure 6-14. The location of permeable brick pavement systems needs to be planned properly at the early design stage to account for traffic volume, de-icing operations and long-term maintenance requirements. Permeable pavements are ideal for low traffic roads, parking lots, driveways, and pedestrian walkways. They are not appropriate for areas with high pollution or sedimentation such as heavy Industrial Developments, Commercial gas stations sites or refueling areas, demolition areas, outdoor storage and handling areas for hazardous materials, etc.

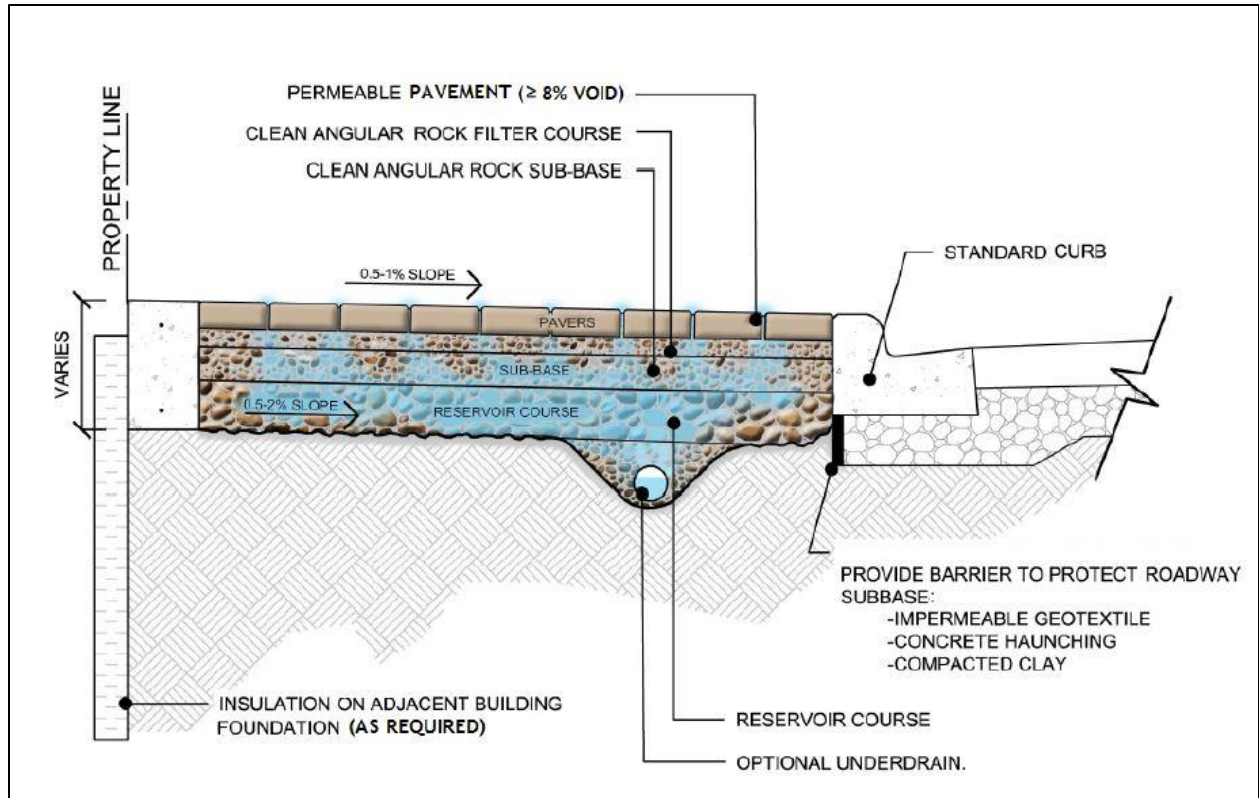

Figure 6-14 - Permeable Brick Pavers

6.5.6.1 PAVEMENT INFILTRATION RATE

The brick pavement must be capable of infiltrating 25 mm/hr over the lifetime of the product based on Manufacturer’s test reports.

6.5.6.2 BRICK PAVERS

Brick pavers shall conform to either ASTM C902 or ASTM 1272. Brick pavers shall have lugs or shall be shaped to accommodate open joints between adjacent pavers with joints at least 6.4 mm wide for adequate permeability. Joints shall not be more than 13 mm wide for accessibility. **Do not fill joints with sand.** Joints shall be filled with a washed, permeable aggregate which conforms to the aggregate requirements in

Table 6-13.

Table 6-13 - Brick Paver Joint Aggregate - Gradation Requirements

Sieve Size (mm)	percent Passing
12.5	100
9.5	85-100
4.75	10-30
2.36	0-10
1.18	0-5

Note: All joint aggregate shall be washed with less than 2% passing the 75 µm sieve. Crushed, angular aggregate is preferred over rounded aggregate.

6.5.6.3 MEDIA LAYERS

Immediately below the underside of the brick paver shall be a filter layer 100 mm in depth in accordance with the gradation in Table 6-14.

Table 6-14 - Brick Paver Filter Layer - Gradation Requirements

Sieve Size (mm)	percent Passing
37.5	100
25	95-100
12.5	25-60
4.75	0-10
2.36	0-5

Note: All joint aggregate shall be washed with less than 2% passing the 75 µm sieve. Crushed, angular aggregate is preferred over rounded aggregate. The filter layer shall be compacted in one single 100mm lift. Assume 35% voids.

Immediately below the filter layer shall be a base layer 600 mm – 1000 mm in depth in accordance with the gradation in Table 6-15.

Table 6-15 - Brick Paver Base Layer - Gradation Requirements

Sieve Size (mm)	percent Passing
75	100
63	90-100
50	35-70
37.5	0-15
19	0-5

Note: All joint aggregate shall be washed with less than 2% passing the 75 µm sieve. Crushed, angular aggregate is preferred over rounded aggregate. Assume 40% voids.

6.5.6.4 PERFORATED UNDERDRAIN PIPE

The diameter of the perforated underdrain pipe shall be 200 mm, when required.

6.5.6.5 COMPUTATIONS

Computations shall be provided for the 100-year runoff, volume, and capacity of retention facility.

6.5.6.6 DRAWDOWN

The washed stone reservoir shall fully drain in 24 hours or less.

6.5.6.7 GEOTEXTILE FABRIC

A non-woven needle-punched or woven monofilament geotextile fabric shall be placed around the top, sides and bottom of the drainage media layer to control sediment migration. Woven slit film and non-woven heat bonded fabrics shall not be used as they are prone to clogging. Suitable Apparent Opening Sizes (AOS) for non-woven fabrics or percent Open Area (POA) of woven fabrics shall be selected. Table 6-11 and Table 6-12 represent the minimum acceptable requirements for non-woven and woven geotextile fabrics, respectively. Note: (1) the hydraulic conductivity (k) of the geotextile, be it woven or non-woven, must be greater than the hydraulic conductivity of the existing soil. (2) the permittivity = $k_{\text{fabric}} / \text{thickness}_{\text{fabric}}$.

6.5.6.8 GROUNDWATER DEPTH

The base of the washed stone reservoir shall be 1.0 m above the seasonal high groundwater elevation or bedrock elevation.

6.5.6.9 BUILDING SETBACK

Permeable pavement shall be located four meters downslope from building foundations.

6.5.6.10 PAVEMENT MAINTENANCE

Periodic vacuum sweeping and preventative measures such as not storing snow or other materials on the pavement are essential to the minimization of clogging.

7 SANITARY SEWER SYSTEM

The municipal sanitary sewer system is a dendritic network of underground pipes which transports wastewater from Residential and Non-Residential developments, including some stormwater inflow and infiltration, to the Riverhead Wastewater Treatment Facility at the St. John's Harbour. These types of urban infrastructure function quietly and efficiently outside of the public eye. This Division is intended to help Engineers and Developers who design and operate wastewater collection systems.

The sanitary sewer system shall be designed as a separate system from the storm sewer system – new designs for combined systems are not permitted.

Sanitary sewers must be designed to convey all design flows with the hydraulic grade line (HGL) at or below the obvert of the pipe.

Any sanitary sewer system or part of a sanitary sewer system shall be designed to serve the area within the Development boundary plus any areas which are tributary to the system.

7.1 HYDRAULIC GRADE LINE REQUIREMENTS

All new and infill sanitary sewer mains and sanitary sewer service laterals shall be designed to operate under free flow conditions at all times – i.e. the Hydraulic Grade Line must be less than or equal to the obvert of the sewer in all cases for new design.

7.2 SANITARY SEWER DRAINAGE AREA

The drainage area for sanitary sewer design purposes may be determined from topographical mapping showing contour lines having an interval not exceeding one metre. The design drainage area shall include all other areas which may become tributary through regrading, underground piping and/or pumping.

7.2.1 DRAINAGE PLAN

A PDF of the sanitary sewer drainage area must be submitted for review and approval, along with ArcGIS polygon shape files containing the boundaries for the drainage area along with the boundary for each subarea. The drainage area plan shall be to a scale of 1:500 or as approved. The drainage area plan shall generally show the following information:

- I. Existing and proposed streets, parking areas, and buildings;
- II. Existing and proposed infrastructure;

- III. The diameter, material, and slope of proposed sanitary sewers; and
- IV. Tributary areas to each sanitary manhole, the size of the tributary area in hectares, and design flow for each tributary area

7.3 PEAK DESIGN FLOWS

The design of new infill sanitary sewer mains and sanitary sewer service laterals will be based on the ultimate sewage flows permitted by zoning (including any proposed rezonings) and expected flow from all tributary drainage areas. The design of new and infill sanitary sewer mains and sanitary sewer service laterals shall account for all flow contributions in the determination of the peak design flow.

7.3.1 CALCULATION OF PEAK DESIGN FLOWS

The peak design flow for new and infill sanitary sewer mains and sanitary sewer service laterals for Development is calculated from the following formula:

$$Q_s = \frac{PqM}{86.4} + \frac{IA}{86.4} + SN \quad (7.1)$$

Where:

Q_s = Peak design flow, in liters per second (see Table 7-1)

P = Design population, in thousands

q = Average daily per capita domestic flow, in L/cap/d (exclusive of extraneous flows)

M = Peaking factor, as per Harmon Formula (equation 7.2)

$$M = 1 + \frac{14}{4 + P^{0.5}} \quad (7.2)$$

I = Unit of peak extraneous flow, in L/s/ha

A = Tributary Area, in hectares

S = Unit of Manhole inflow allowance for each manhole in sag location, in liters per second

N = Number of Manholes in sag location

7.3.1.1 WASTEWATER FLOWS

Table 7-1: Wastewater Flows (Average Daily)

(From ACWWA Atlantic Canada Wastewater Guidelines, May 2022)

Type of Establishment		(L/day)
Residence	Private dwelling	380 per person
	Apartment building	380 per person
Transient Dwelling Units	Hotels	380 per bedroom
	Lodging houses and tourists homes	270 per bedroom
	Motels and tourist cabins	300 per bedroom (add for restaurant)
Industrial and Commercial Buildings	Does not include process water or cafeteria	45 per employee
	With showers	90 per employee
Camps	Campsite	500 per campsite
	Trailer camps (private bath)	380 per person
	Trailer camp (central bath, etc.)	230 per person
	Trailer camp (central bath, laundry)	300 per person
	Luxury camps (private bath)	380 per person
	Children's camps (central bath, etc.)	230 per person
	Labour camps	225 per person
	Day camps - no meals	70 per person
Restaurants (including washrooms)	Average type (2 x fire commissioners capacity)	225 per seat + 100 per employee
	Bar/cocktail lounge (2 x fire commissioners capacity)	25 per patron
	Short order or drive-In service	25 per patron
	24 -hour	225 per seat
	Non 24-hour	160 per seat
Clubhouses	Residential type	380 per person
	Non-Residential type (serving meals)	160 per person
	Golf club	40 per member
	Golf club (with bar and restaurant)	115 Seat
Institutions	Hospitals	950 per bed
	Other institutions	450 per resident
Schools	Basic	50 per person
	With cafeteria	70 per person
	With cafeteria and showers	90 per person
	With cafeteria, showers, and laboratories	115 per person
	Boarding	380 per person
Theatres	Theatre (indoor)	25 per seat
	Theatre (drive-in with food stand)	25 per car
Automobile Service Stations	No car washing	20 per car served
	Car washing	340 per car washed

Type of Establishment		(L/day)
Miscellaneous	Stores, shopping centres, and office buildings	6 per m ²
	Factories (8-hour shift)	115 per person
	Self-service laundries	1800 per machine
	Bowling alleys	900 per alley
	Swimming pools and beaches	70 per person
	Picnic parks (with flush toilets)	50 per person
	Fairgrounds (based upon average attendance)	25 per person
	Assembly halls	35 per seat
	Airports (based on passenger use)	15 per passenger
	Churches (no kitchen)	25 per seat
	Churches (with kitchen)	35 per seat
	Beauty parlours	200 per seat
	Barber shops	75 per seat
	Hockey rinks	15 per seat
	Daycare centre	115 per child
	Liquor licence establishments	115 per seat
	Mobile home parks	1350 per space
	Nursing and rest homes	450 per resident
	Senior citizen home	600 per apartment
	Recreational vehicle park	180 per space

7.3.1.2 EXTRANEEOUS FLOWS

Inflow and Infiltration

Inflow refers to drain connections to the sanitary sewer, while infiltration refers to groundwater seeping into the sanitary sewer due to condition of pipe and joins. Generally, no drains are permitted to be connected to the sanitary sewer in new Developments. However there should be an allowance for inflow and infiltration to account for existing systems and the possibility of infiltration at private properties.

The minimum allowance for inflow and infiltration shall be 0.3 L/s/ha.

Manholes in Sag Locations

Where manholes are located in sag locations on roadways or elsewhere, the sanitary design peak flow shall be increased by 0.4L/s for each instance.

7.3.2 DETERMINATION OF CAPACITIES IN EXISTING SANITARY SEWER SYSTEMS

The City may require that the determination of available capacities in existing sanitary sewer systems be based on flow monitoring data indicating the actual dry and wet weather flow rates. Wet weather flow monitoring must take place during the late Spring

(April and May) or early Fall (September and October) in order to collect flow data during extreme weather events.

7.4 HYDRAULICS

The hydraulic design of sanitary sewer systems is contained in this section.

7.4.1 SANITARY SEWER CAPACITY

Sanitary sewer capacities shall be calculated using the following formula:

$$Q_c = 76923AR^{0.67}S^{0.50} \quad (7.3)$$

Where:

Q = Full flow sewer capacity, in liters per second

A = Full cross-sectional area of flow, in square meters

R = Hydraulic radius = $A/P = D/4$, in meters for circular pipes

P = Wetted perimeter, in meters

S = Longitudinal slope, in meter per meter

7.5 SANITARY SEWER MAIN DESIGN

7.5.1 PIPE SIZE

The minimum diameter of sanitary sewer mains shall be 200 mm.

7.5.2 MINIMUM VELOCITY

The minimum acceptable velocity at peak design flow for sanitary sewer mains shall be 1.0 m/s to ensure self-cleansing. In instances where the minimum velocity of 1.0 m/s cannot be achieved, the minimum allowable pipe gradient shall increase to 1.00 %.

7.5.3 MAXIMUM VELOCITY

The maximum allowable velocity at peak design flow for sanitary sewer mains shall be 4.5 m/s.

7.5.4 MINIMUM PIPE SLOPE

The minimum allowable pipe slope for sanitary sewer mains shall be 1.0% in the first 120 m at the top end of any leg of a sanitary sewer main. All remaining downstream sections of sanitary sewer mains shall have a minimum allowable pipe slope of 0.5% and meet the minimum self-cleansing velocity requirements of Section 7.5.2.

7.5.5 MAXIMUM PIPE SLOPE

The maximum allowable pipe slope for sanitary sewer mains shall be 20% and is subject to meeting the maximum velocity criteria of Section 7.5.3.

7.5.6 PIPE MATERIAL

The materials for sanitary sewer mains shall conform to the requirements of the City of St. John's Specification Book. All sanitary sewer must have smooth interior walls.

7.5.7 PIPE BEDDING

The type of bedding for sanitary sewer mains shall be selected to suit loading and proposed construction conditions and must conform to the requirements of the City of St. John's Specification Book. The pipe material, class, and type of bedding shall be shown on the profile drawings for each section of sanitary sewer.

7.5.8 PIPE CLASS

Pipe class shall be selected to suit the type of bedding, final buried depth, and surface loading and must conform to the requirements of the City of St. John's Specification Book.

7.5.9 MINIMUM DEPTH OF COVER

The minimum depth of cover for new sanitary sewer mains shall be 3.0 m measured from the finished ground elevation to the obvert of the pipe.

7.5.10 MAXIMUM DEPTH OF COVER

The maximum depth of cover for new sanitary sewer mains shall be 4.0 m measured from the finished ground elevation to the obvert of the pipe – subject to selection of a suitable pipe class. Deeper sewers may be approved by the City in exceptional circumstances.

7.5.11 LOCATION AND ALIGNMENT

Sanitary sewer mains shall be located such that manholes are placed in the centre of driving lanes, wherever possible, unless there is a conflict with other existing utilities. Exceptions will occur on curved streets. In order to avoid excessive surface water entering sanitary manholes, the manholes shall be located at least 1.5 m from the curb line and away from low points.

Where a sanitary sewer is to be installed in the same trench as a storm sewer, the arrangement of the two pipes shall be in accordance with the City of St. John's Specification Book.

7.5.12 VERTICAL SEPARATION – PIPE CROSSINGS

Any sanitary sewer main crossing another sewer shall have a minimum vertical clearance of 300 mm between the outside walls of the pipes.

A minimum vertical clearance of 450 mm is required between the outside wall of a sanitary sewer main (or the outside wall of a sanitary sewer service lateral) and the outside wall of any watermain. This shall be the case whether the watermain is above or below the main or lateral. The City's preference is that the watermain is located above the main or lateral.

7.5.13 HORIZONTAL SEPARATION BETWEEN PIPES

The minimum horizontal separation between a new sanitary sewer main and an existing or proposed watermain is 3.0 m measured from outer wall to outer wall. In cases where it is not practical to maintain separate trenches or the recommended horizontal separation cannot be achieved then the City may consider a deviation on a case-by-case basis.

The minimum horizontal separation between a new sanitary sewer main and an existing or proposed sanitary sewer main is 3.0 m measured from outer wall to outer wall. In cases where it is not practical to maintain separate trenches or the recommended horizontal separation cannot be achieved then the City may consider a deviation on a case-by-case basis.

7.5.14 HIGH WATER TABLE CONDITIONS

A geotechnical report may be required to establish the seasonal high groundwater elevations within the area of the Development. Where there exists a possibility, in the sole discretion of the City, that groundwater may be diverted and follow the path of the new sanitary sewer main then groundwater barriers shall be constructed in adequate numbers to prevent groundwater migration along the sanitary sewer main trenches.

7.5.15 CONTAMINATED SOIL CONDITIONS

A geotechnical report will be required to determine if there is any contaminated soil within the area of the Development. Any contaminated soil must be excavated and removed.

7.6 SANITARY SEWER SERVICE LATERALS

All sanitary sewer service laterals, fittings, appurtenances shall be designed in accordance with the City of St. John's Specification Book, the National Building Code of Canada, and this Manual. Where there is a conflict between these documents then the more stringent requirements shall take precedence. Separate sanitary sewer service laterals shall be provided for each separately owned dwelling unit.

7.6.1 SERVICE LATERAL LOCATIONS

Sanitary sewer service laterals must not be located within 3.0 m of the side boundary of a building lot or any outdoor fuel tank. There shall be a minimum 3.0 m separation from any electrical/telecommunication lines or conduits, transformer pads, utility poles, driveways, or any other utility.

7.6.2 PIPE SIZE

The size of the sanitary sewer service lateral shall be large enough to accommodate the peak design flow generated by the property. The minimum diameter of a sanitary sewer service lateral shall be 100 mm. Sanitary sewer service laterals greater than 100mm diameter require manholes for changes in direction and maximum spacings equal to or greater than 120 m. Manholes are required on all laterals for Commercial sites.

Sanitary sewer service laterals are not permitted to decrease in size from the building to the sanitary sewer main.

7.6.3 MINIMUM PIPE SLOPE

The minimum allowable pipe slope for 100 mm diameter sanitary sewer service laterals shall be 2.0%.

7.6.4 MAXIMUM PIPE SLOPE

The maximum allowable pipe slope for 100 mm diameter sanitary sewer service laterals shall be 8.0%.

7.6.5 PIPE MATERIAL

The materials for sanitary sewer service laterals shall conform to the requirements of the City of St. John's Specification Book. All sanitary sewer service laterals must have smooth interior walls.

7.6.6 PIPE BEDDING

The type of bedding for sanitary sewer service laterals be selected to suit loading and proposed construction conditions and must conform to the requirements of the City of St. John's Specification Book. The pipe material, class, and type of bedding shall be shown on the profile drawings for each section of sanitary sewer.

7.6.7 PIPE CLASS

Pipe class shall be selected to suit the type of bedding, final buried depth, and surface loading and must conform to the requirements of the City of St. John's Specification Book.

7.6.8 MINIMUM DEPTH OF COVER

The minimum depth of cover within the street Right-Of-Way for sanitary sewer service laterals shall be 2 m measured from the finished ground elevation to the obvert of the pipe.

7.6.9 MAXIMUM DEPTH OF COVER

The maximum depth of cover for sanitary sewer service laterals shall follow the Manufacturer's recommendations but in no case shall be deeper than 4 m.

7.6.10 CONNECTIONS TO EXISTING MAINS

For 100 mm diameter sanitary sewer service laterals, connections into existing sanitary sewer mains shall be made with an INSERTA-TEE provided that the diameter of the sanitary sewer main is 200 mm or greater. The invert of the sanitary sewer service lateral connection shall be above the spring line of the sanitary sewer main.

For Residential sanitary sewer service laterals with diameters greater than 100 mm, the connection requirements into existing shall be reviewed on a case-by-case basis. Residential sanitary sewer service lateral connections will not normally be permitted into sanitary manholes.

Non-Residential sanitary sewer service laterals greater than 100 mm diameter shall connect into an existing or new sanitary manhole.

Stormwater service laterals, drains, roof drains, and foundation drains shall not be connected to any part of the sanitary sewer system.

7.6.11 CONNECTIONS TO NEW MAINS

For 100 mm diameter sanitary sewer service lateral connections into new sanitary sewer mains shall be made with an inline tee in accordance with the City's Specification Book. The invert of the sanitary sewer service lateral connection shall be above the spring line of the sanitary sewer main.

For Residential sanitary sewer service laterals with diameters greater than 100mm, the connection requirements into new sanitary sewer mains shall be reviewed on a case-by-case basis. Residential sanitary sewer service lateral connections will not normally be permitted into sanitary manholes.

Non-Residential sanitary sewer service laterals larger than 100mm diameter shall connect into a new sanitary manhole.

Stormwater service laterals, drains, roof drains, and foundation drains shall not be connected to any part of the sanitary sewer system.

7.6.12 GROUNDWATER MITIGATION

The Design Engineer shall assess the possibility of groundwater migration through the sanitary sewer main and the sanitary sewer service lateral trenches resulting from the use of pervious bedding material. Corrective measures, including provision of impermeable collars or plugs, to reduce the potential for basement flooding resulting from groundwater migration shall be employed where necessary.

7.6.13 SERVICE LATERAL CONNECTION ABANDONMENT

Sanitary sewer service laterals are required to be abandoned at the main for all City of St. John's Demolition permits where there is no application to rebuild. For Demolition/Rebuild permits the sanitary sewer service lateral connections can be abandoned a minimum 3 m from the existing foundation. A temporary endcap shall be installed at the terminus. The method for abandonment is dependent on the site conditions specific to the service connection in question. The City of St. John's will determine the abandonment method to be used on a case-by-case basis.

7.6.14 SERVICE LATERAL CONNECTION REUTILIZATION

An existing sanitary sewer service lateral connection may be reused subject to the requirements of the City's *Replacement of Property Laterals when Redeveloping Residential Property* Policy and if all the following conditions are met: (a) the proposed land use, building use, and sanitary flow rate are known; (b) the sanitary sewer service lateral is of adequate size and meets current material specifications; and (c) a TV inspection video and report of the sanitary sewer service lateral is provided confirming, at the sole discretion of the City, that the lateral's condition warrants reuse.

7.7 MANHOLES

7.7.1 MANHOLE LOCATION

Manholes shall be located at every change of horizontal and vertical alignment, at every change of pipe size and/or material, and at dead ends. No manholes are to be located within 3.0 m of an overhead electrical line. Manholes shall be clear of curb and gutters and clear of bends in the road for new construction.

Sanitary manholes located within street Right-Of-Ways shall be placed in the quarter-point of the driving surface, wherever possible.

7.7.2 MANHOLE SPACING

The maximum allowable spacing for new sanitary manholes shall be 120 m.

7.7.3 MANHOLE SIZING

All sizing of sanitary manholes are based on inlet and outlet pipe sizes and sanitary manholes shall be sized according to the standard drawings in the latest version of the City's Specification Book. The minimum internal diameter for precast concrete sanitary manholes is 1200 mm.

The type and size of sanitary manholes will be specified on the profile drawings. When any dimension of a proposed sanitary manhole differs from the City of St. John's Specification Book then that sanitary manhole shall be individually designed and detailed by a Structural Engineer licenced to practice in the Province of Newfoundland and Labrador. Structural drawings and details shall be submitted to the City for review.

7.7.4 MANHOLE ACCESS FRAMES AND COVERS

Manhole access frames and covers are required for all manholes and will be in accordance with the City of St. John's Specification Book. All manhole access frames and covers shall be located on the upstream side of the manhole.

7.7.5 WATERTIGHT MANHOLE COVERS

Watertight bolt down manhole covers are required when sanitary sewer main manholes are located within stormwater low points, areas of inundation, and overland flow routes. Watertight bolt down manhole covers will also be required to be installed at locations where it is necessary, in the sole discretion of the City, to protect against possible surcharge conditions.

Where significant sections of sanitary sewer main are provided with watertight bolt down covers, extended vents will be required at every third manhole to prevent excessive build up of sulphides. The elevation of the vents to be above the 100-year high water mark for the area.

7.7.6 LOCKABLE MANHOLE COVERS

The City will require lockable watertight manhole covers on pump stations, flow monitoring stations, and other locations as deemed necessary by the City.

7.7.7 MANHOLE LADDER RUNGS

All manholes shall have aluminium climbing steps (ladder rungs) as per the City of St. John's Specification Book.

7.7.8 MANHOLE DROP STRUCTURES

External drop pipes shall be provided when the difference in invert elevations between the inlet and the outlet pipe inverts is greater than 1.0 m. The external drop pipe shall be one size smaller than the sanitary sewer main but the drop pipe shall be no smaller than 200 mm diameter. At the City's sole discretion, a drop manhole may not be permitted. External drop manholes shall be constructed as per the standard detail in the City of St. John's Specification Book.

When the difference in elevation between the manhole inlet and outlet pipes exceeds 1.0 m then a drop structure shall be provided. When the drop is between 200 mm and 1000 mm then pipe grades shall be adjusted such that the maximum drop is 200 mm.

Internal drop pipes – if considered – require the internal manhole diameter to be increased by at least one pipe size and it must be demonstrated that access will not be compromised. Internal drop pipes shall be secured to the interior wall of the manhole by an approved fastening method. Internal drop pipes will only be considered if the use of an external drop pipe, in the sole discretion of the City, is not possible.

7.7.9 MANHOLE SAFETY LANDINGS

When the depth from the sanitary sewer main manhole invert to the finished manhole cover elevation exceeds 5.0 m then a safety landing shall be provided. Additional safety landing shall not be more than 5.0 m apart. Access hatches in safety landings shall line up to allow proper use of fall arrest equipment.

7.7.10 MANHOLE BENCHING

Benching of sanitary manholes shall conform with the City of St. John's Specification Book. Benching height shall extend from the pipe invert to improve hydraulic performance. If there is an intent to differ from the City of St. John's Specification Book then a benching detail must be provided on the engineering drawings for review.

7.7.11 HYDRAULIC LOSSES AT MANHOLES

See Section 6.3.1.10.

8 WATER DISTRIBUTION SYSTEM

8.1 INTRODUCTION

The water distribution system shall be designed and constructed in accordance with the requirements of this Manual, the requirements of the water distribution and transmission plans of the City of St. John's, and the City of St. John's Specification Book.

8.2 WATER DEMANDS AND FACTORS

Water distribution systems shall be designed for the greater of the maximum day demand plus fire flow demand or the peak hour demand. The average daily demand (ADD) rates shall be appropriately selected from Table 8-1.

Table 8-1 - Water Distribution Average Daily Demand Rates

Land Use	Average Daily Demand Rate (Litres/hectare/day)
Residential	12,222
Light Commercial	31,111
Commercial Core	100,000
Light Industrial	43,333
Heavy Industrial	187,222
Institutional	37,778

For all other uses, a demand rate will be as determined by the City.

For hydraulic design, the rates from Table 8-1 shall be utilized with the following factors: 0.70 for minimum hour demand, 1.5 for maximum day demand, and by 2.5 for peaking hour demand.

The fire flow demand shall be calculated using the latest requirements from "Water Supply for Public Fire Protection" by the Insurance Advisory Organization and shall be confirmed by the St. John's Regional Fire Department, when required.

8.3 HYDRAULIC DESIGN

The City may require Developers to determine the water distribution system flows, velocities, and pressures under (i) maximum day demand plus fire flow demand; (ii) peak hour demand; and (iii) minimum hour demand for existing and proposed conditions. This would be achieved through an acceptable hydraulic modelling software.

8.3.1 HAZEN-WILLIAMS

The friction losses through watermains and service laterals shall be calculated using the Hazen-Williams formula in Equation (8.1).

$$h_L = \frac{10.7L}{C^{1.85}D^{4.87}} Q^{1.85} \quad (8.1)$$

Where:

h_L = Head loss due to friction, in meters

L = Length of pipe, in meters

C = Friction factor

D = Diameter of pipe, in meters

Q = Flow through pipe, in cubic meters per second

8.3.1.1 FRICTION FACTORS

The friction factor, C , to be used in the design of new water distribution systems shall be selected from Table 8-2.

Table 8-2 - Hazen-Williams Friction Factors

Watermain Diameter (mm)	C
150	100
200-250	110
300-600	120
>600	130

When analyzing existing water distribution systems the friction factor, C , shall be determined by actual field test, whenever possible.

8.3.2 FIRE FLOW DETERMINATION

Fire flows shall be calculated based on the following formula.

$$Q_F = K_1 K_2 K_3 K_4 \sqrt{A} \quad (8.2)$$

Where:

Q_F = Required fire flow, in liters per minute

K_1 = Construction material factor, see Table 8-3

K_2 = Fire hazard factor, see Table 8-4

K_3 = Automated protection factor, see Table 8-5

K_4 = Exposure factor, see Table 8-6

A = Total floor area (including all storeys) in square meters (exclude basements that are at least 50% below grade).

Table 8-3 - Construction Material Factors for Equation (8.2)

Primary Construction Material	K ₁
Wood-frame (all combustible)	330
Masonry (combustible interior)	220
Unprotected metal structure (masonry or metal walls)	176
Fully protected fire-resistive structure	132

Table 8-4 - Fire Hazard Factors for Equation (8.2)

Occupancy Contents	K ₂
Non-combustible	0.75
Limited combustible	0.85
Combustible	1.00
Free burning	1.15
Rapid burning	1.25

Table 8-5 - Automated Protection Factors for Equation (8.2)

Protection System Type	K ₃
(1) Designed to NFPA standards	0.70
(1) plus (2) water flow and control valve alarm system	0.60
(1) and (2) plus fully Supervised system	0.50

Note: If the structure does not have a sprinkler system then K₃ = 1.

Table 8-6 - Exposure for Equation (8.2)

Separation (in meters) per Side	K ₄
0.0-3.0	1.25
3.1-10.0	1.20
10.1-20.0	1.15
20.1-30.0	1.10
30.1-45	1.05

Note: K₄ shall be determined for each side of the building and a total percentage shall be determined based on the sum of the K₄ values. This summated value shall not exceed 1.75. If all sides have separation greater than 45 meters from adjacent structures then K₄ = 1.

The required fire flow calculated by Equation (8.2) shall not exceed 45,000 liters per minute nor shall it be less than 2,000 liters per minute. Wood-frame structures separated by less than 3 meters shall be considered as one fire area.

8.3.2.1 FIRE FLOW DURATION

The required duration (t) of the fire flow is selected from Table 8-7.

Table 8-7 - Required Duration of Fire Flow

Require Fire Flow (Liters per minute)	Duration (t) (Hours)
2,000 or less	1.00
3,000	1.25
4,000	1.50
5,000	1.75
6,000	2.00
8,000	2.00
10,000	2.00
12,000	2.50
14,000	3.00
16,000	3.50
18,000	4.00
20,000	4.50
22,000	5.00
24,000	5.50
26,000	6.00
28,000	6.50
30,000	7.00
32,000	7.50
34,000	8.00
36,000	8.50
38,000	9.00
40,000 and over	9.50

8.3.3 PRESSURE REQUIREMENTS

Minimum desirable residual pressure under maximum day plus fire flow conditions shall be 150 kPa at ground level of any point in the system.

Minimum desirable residual pressure under peak hour flow conditions shall be 300 kPa at ground level of any point in the system.

8.3.4 MAXIMUM VELOCITY

The maximum velocity in a watermain shall not exceed 1.5 m/s during the peak hour demand flow conditions and shall not exceed 2.4 m/s during fire flow conditions.

8.4 GENERAL DESIGN

8.4.1 CONNECTIONS TO EXISTING WATER SYSTEM

Connections to the City's existing water system are to be made only by the Water and Wastewater Division of the Department of Public Works.

8.4.2 DEAD END WATER MAINS

The water system shall be designed to exclude any dead end sections of water main. All efforts must be made to loop water mains on cul-de-sacs back to another main. If not possible, water mains in cul-de-sacs must be looped as outlined in the City of St. John's Specification Book.

8.4.3 WATERMAIN MINIMUM SIZES

Water mains shall generally be sized in accordance with the requirements of the water distribution and transmission plans of the City of St. John's.

The minimum diameter of water main pipes shall be as follows:

Transmission Mains	300mm
Local Distribution Mains	200mm
Hydrant Leads	150 mm

8.4.4 DEPTH OF COVER

All water mains and services shall have a minimum cover of 2000 mm from crown of pipe to finished grade.

For any streets not completed prior to December 1 of any year, the required depth of cover over the water main shall be provided by placing approved material of sufficient depth to satisfy the depth of cover requirement.

8.4.5 LOCATION OF WATER MAINS

All water mains shall normally be placed at the quarter point of the street Right-Of-Way.

Where a water main is placed other than in a public street, the location of the water main must receive prior approval from PERS and appropriate Easements will be required.

Watermains shall be laid at least 3 m horizontally from any existing or proposed sewer. The distance shall be measured edge to edge. In cases where it is not practical to maintain a 3 m separation, the City may allow installation of the watermain closer to a sewer, provided that:

- I. The watermain is laid in a separate trench, or on an undisturbed earth shelf located on one side of the sewer; and
- II. At such an elevation that the bottom of the watermain is at least 450 mm above the top of the sewer and 300 mm horizontal measured edge-to-edge.

If separate trenches are used then the soil between the trenches must be undisturbed.

Watermains crossing sewers shall be laid to provide a minimum vertical distance of 450 mm between the outside of the watermain and the outside of the sewer. This shall be the case where the watermain is either above or below the sewer with preference to the watermain located above the sewer. At crossings, above or below, one full length of water pipe shall be located so both joints will be as far from the sewer as possible. Special structural support for the water and/or sewer pipes may be required.

There shall be at least 3 m horizontal separation between watermains and sanitary sewer forcemains. When crossing, the watermain shall be above the forcemain with a vertical separation of a minimum 450 mm at the crossing.

Where it is anticipated that watermains and forcemains will conflict at the crossings, then the forcemain shall be lowered in order to achieve the minimum 450 mm separation.

The horizontal separation between a water service and a catch basin barrel shall be 3m or greater centreline to centreline.

8.4.6 VALVES

Use gate valves for 300 mm watermains and smaller. Butterfly or gate valves shall be used for watermains 350 mm and larger.

8.4.6.1 LOCATION OF VALVES

Valves at street intersections shall be located in the roadway at the points of intersection of the street Right-Of-Way with the watermain.

Where water mains intersect, the appropriate number of valves required to allow complete isolation of the system shall be installed.

The maximum allowable distance between valves on straight sections of watermain shall be 180 m.

The placement of valves is to be such that any section of the system can be isolated by turning off a maximum of four valves. This isolated section in a looped system may contain up to a maximum of 45 single family services and no more than one hydrant taken out of service.

8.4.6.2 VALVE CHAMBERS

All valves on watermains shall be direct bury, as per the requirements of the City of St. John's Specification Book. Valve chambers are not required.

8.4.6.3 AIR RELIEF & VACUUM VALVES

Air relief and vacuum valves are to be installed, in chambers, at all significant high points in the water distribution system and at such locations as required for efficient operation of the system.

8.4.7 PRESSURE REDUCING VALVES

Pressure reducing valves are to be installed as required to maintain acceptable pressures within the City's pressure zones for the water distribution system.

8.4.8 HYDRANTS

Public hydrants shall be placed behind sidewalks within the limits of the street Right-Of-Way.

Public hydrants shall normally be placed on the extension of the boundary line between two building lots, if the driveways are not located on the same side

The minimum distance from the edge of a driveway to the centre of a public hydrant shall be 1.5 m.

Public hydrants shall be placed on the high points of the water system if air release valves are not provided.

The minimum distance from the centre of a utility pole to the centre of a public hydrant shall be 3.0 m.

In Residential areas, the maximum permissible spacing between public hydrants shall be 140 m. No dwelling unit shall be located more than 70 m from a hydrant.

Public hydrants shall not normally be located in the bulb area of cul-de-sac streets.

Hydrants shall be installed so that the top of the standpipe flange will be located between 100 mm and 150 mm above the finished grade of the curb in front of the hydrant.

A valve shall be installed on all 150 mm diameter hydrant leads. The hydrant lead valve shall be located at least 2.0 m from the center of the water main to which the hydrant lead connects. The hydrant valve shall be located at least 2.0 m from the hydrant to permit operation of the valve.

In Commercial, Industrial, and Institutional areas, the maximum permissible spacing between public hydrants shall be 90 m with hydrants staggered on opposite sides of the street.

Where a hydrant serves a building(s) that is provided with a Siamese connection, the hydrant shall be located not more than 45 m unobstructed from the Siamese connection(s). Where the building(s) is not provided with a Siamese connection, the main entrance and all portions of the exterior wall are to be no more than 90 m unobstructed from a fire hydrant. Where a public hydrant does not meet the aforementioned distances then a private hydrant will be required. Private hydrants shall be painted red. All private hydrants are required to comply with the City's Premises Isolation By-Law.

The minimum distance between the center of an underground electrical duct and the center of a hydrant shall be 3.0 m.

8.4.9 MATERIAL SPECIFICATIONS

Watermain, hydrant and valve materials must meet the requirements of the appropriate sections of the City of St. John's Specification Book.

8.4.10 WATER SERVICE PIPE

Water service pipe material shall conform to the requirements of the City of St. John's Specification Book.

Separate water service pipes shall be provided for each separately owned dwelling unit. If possible, water services shall be installed at the center of Residential lots along the frontage of the property. Rear yard servicing will not be permitted. Water service pipes must not be located within 3.0 m of the side boundary of a building lot.

8.4.11 WATER SERVICE PIPE SIZE

The minimum water service size shall be calculated based on the requirements provided in the City of St. John's Specification Book. The minimum diameter of water service pipe shall be 25 mm.

8.4.12 UNDERGROUND ELECTRICAL INFRASTRUCTURE

Underground primary electrical ducts must be encased in concrete when crossing underground water infrastructure.

There shall be a minimum 750 mm horizontal separation between the outside edge of underground electrical ducts and the curb stops on the Residential lots.

8.4.13 GROUNDWATER MITIGATION

The Design Engineer shall assess the possibility of groundwater migration through the watermain and the water service lateral trenches resulting from the use of pervious bedding material. Corrective measures, including provision of impermeable collars or

plugs, to reduce the potential for basement flooding resulting from groundwater migration shall be employed where necessary.

8.4.14 SERVICE LATERAL CONNECTION ABANDONMENT

Service laterals are required to be abandoned at the watermain for all City of St. John's Demolition permits where there is no application to rebuild.

8.5 WATER SUPPLY STORAGE RESERVOIRS

For the purpose of this Manual, a water supply storage reservoir refers to an aboveground water storage structure that is constructed using prestressed concrete or bolted glass-fused-to-steel. The structure must conform with the latest CSA/ANSI or AWWA standards.

Water supply storage reservoirs will be considered at the discretion of the City in areas with insufficient volume or pressure for servicing. They must be designed in coordination with the regional system. Regional reservoirs will be preferred over those servicing single developments.

The materials and design for the water supply storage reservoir structure shall provide stability, durability, and water quality protection.

The storage reservoir shall have adequate capacity to meet domestic demands and fire flow demands.

8.5.1 SIZING OF WATER SUPPLY STORAGE RESERVOIR

The required volume of a water supply reservoir is calculated from the following equation:

$$V_S = F_S + O_S + E_S \quad (8.3)$$

Where:

V_S = Reservoir storage volume, in cubic meters,

F_S = Fire storage, in cubic meters based on the required fire flow over the required duration (see Section 8.3.2),

O_S = Operational storage, in cubic meters (25% of maximum day demand)

E_S = Emergency storage, in cubic meters (25% of $F_S + O_S$)

8.5.1.1 FIRE STORAGE

Fire storage is calculated using Equation (8.4)

$$F_S = 0.06Q_F t \quad (8.4)$$

Where:

F_S = Required fire storage, in cubic meters

Q_F = Required fire flow, in litres per minute calculated from Equation (8.2)

t = Required duration of fire flow, in hours from Table 8-7

8.5.1.2 OPERATIONAL STORAGE

Operational storage is the volume required to meet peak demand periods using Equation (8.5).

$$O_S = 0.25 * 1.5 * ADD \quad (8.5)$$

8.5.1.3 EMERGENCY STORAGE

Emergency storage is the volume required during power outages or maintenance shut-downs and is calculated as per Equation 8.6.

$$E_S = 0.25(F_S + O_S) \quad (8.6)$$

8.5.1.4 DEAD STORAGE

Dead storage is the volume of stored water that is not available to all consumers at the minimum design pressure. Dead storage is not included in Equation (8.3) but it may be present in the reservoir and needs to be considered in the overall sizing of the reservoir.

8.5.2 LOCATION OF WATER SUPPLY STORAGE RESERVOIRS

The lowest floor elevation of the reservoir shall be placed at least 0.6 m above the seasonal high groundwater elevation. Sewers, drains, standing water and similar sources of contamination must be located a horizontal distance of at least 15 m from the reservoir.

8.5.3 DESIGN LIFE

All water supply storage reservoirs shall have a design life of 100-years.

8.5.4 PROTECTION FROM CONTAMINATION

All water supply storage reservoir structures shall have appropriately designed watertight roofs which prevent insects, birds, and dust from entering the facility. The installation of any appurtenances (i.e. communication antennae, ladders, sensors, etc.) shall be done in such a manner to ensure that there is no damage to the reservoir, internal or external coatings, or water quality.

8.5.5 SECURITY

A 2.4 m high chain link fence shall surround the reservoir with a minimum 6m wide lockable gate system.

8.5.6 DRAINS

No drain on a water supply storage reservoir shall have direct connection to a sanitary sewer or any component of the stormwater management system. The design of the storage reservoir shall allow for the draining of the facility for cleaning and maintenance without causing a loss of pressure in the distribution system.

8.5.7 STAGNATION

Poor water circulation and long detention times lead to: a reduction of disinfectant residual, disinfectant by-product formation, microbial growth, and taste and odor problems. The storage reservoir shall be designed to facilitate an acceptable rate of turnover in water to minimize stagnation and stored water age and avoid freezing issues.

8.5.8 OVERFLOW

All water supply storage reservoirs shall be designed with an overflow pipe that discharges at 300 mm above ground elevation. The discharge must be into a drainage inlet structure capable of conveying the maximum flow that can pass through the overflow.

- I. The overflow pipe shall be located on the outside of the reservoir.
- II. The outlet of the overflow pipe shall be directed downward and equipped with a duckbill valve to keep out insects and animals. Provisions must be included to prevent the valve from freezing in the Winter months.
- III. The overflow pipe shall be large enough to permit discharge of water in excess of the filling rate.

8.5.9 ACCESS

Water supply storage reservoirs shall have adequate access for the cleaning and maintenance of the interior of the facility. At least two access manholes shall be provided above the top water level for each compartment within the reservoir. Access manholes not located in rooftops shall be bolted and gasketed for watertightness and security.

8.5.9.1 ELEVATED OR DOMED ROOF RESERVOIRS

At least one of the access manholes shall be framed at least 100 mm above the surface of the roof at the opening. All manholes shall be fitted with a solid watertight cover which overlaps the framed opening and extends down around the frame by at least 50 mm. The cover shall be hinged on one side and shall have a locking device which can accommodate a standard City of St. John's padlock.

8.5.10 VENTS

Water supply storage reservoirs shall be vented. The overflow pipe is not acceptable as meeting the venting requirements for storage reservoirs. Open construction between the sidewall and the roof is not permitted. Vents shall: prevent the intrusion of surface water and precipitation; shall prevent the entry of birds and animals; and shall exclude insects and dust. Vents shall open downward with the opening at least 600 mm above the roof and the vent shall be equipped with a removeable twenty-four mesh non-corrodible screen. The screen shall be installed within the vent pipe.

8.5.11 ROOFS AND SIDEWALLS

The roof and sidewalls of all water supply storage reservoirs must be watertight with no openings except properly constructed access manholes, overflows, vents, risers, drains, pump mountings, control ports, inflow pipes or outflow piping.

- I. Any pipes passing through the roof or sidewalls of a metal storage structure shall be welded or properly gasketed. Standard cast-in-place wall castings with seepage rings shall be used in concrete tanks.
- II. Openings in the roof of a storage reservoir for control apparatus or pump columns shall be curbed and sleeved with proper additional shielding to prevent contamination from drainage.
- III. Valves and controls must be located outside the storage reservoir so that valve stems and similar projections do not pass through the reservoir.
- IV. The roof of the storage reservoir shall be well drained and downspout pipe, if required, shall not enter or pass through the reservoir. Precast concrete roof structures must be watertight and will require an impermeable membrane. Parapets will not be approved.

8.5.12 SAFETY

Safety in the design and operation of the water supply storage reservoir is paramount. The following items shall be addressed as part of the design:

- I. Ladders, ladder guards, railings, and safely-located access manholes shall be provided;
- II. Riser pipes over 200mm in diameter shall have protective bars, or approved equal, over the riser openings inside the tank;
- III. Railing and handholds must be provided where persons transfer from the access manhole to the interior of the storage reservoir; and
- IV. The Developer must incorporate confined space entry requirements into the design.

8.5.13 FREEZING

Water supply storage reservoirs and their appurtenances shall be designed to prevent freezing which would impede operations. Equipment used for freeze protection that will come into contact with potable water must meet NSF/ANSI 61-2020. If a water circulation system is used then the circulation pipe must be located separately from the riser pipe.

8.5.14 INTERNAL CATWALK

Each catwalk shall have a solid floor with sealed raised edges designed to prevent contamination from shoe scrapings and dirt.

8.5.15 SILT STOP

The discharge pipe(s) from the water supply storage reservoir(s) shall be located to prevent the flow of sediment into the water distribution system. Removeable silt stops shall be provided.

8.5.16 SITE GRADING

The area surrounding the reservoir shall be graded such that there will be no standing surface water within 15 m of the reservoir.

8.5.17 CATHODIC PROTECTION

Proper protection shall be provided to metal surfaces using cathodic protective devices. Cathodic protection shall be designed and installed by competent technical personnel and a maintenance schedule shall be provided.

8.5.18 DISINFECTION

Completed water supply storage reservoirs shall be disinfected in accordance with AWWA C652. Two or more successive sets of samples (taken at 24-hour intervals) shall be provided indicating that the water is microbiologically satisfactory.

Disposal of the heavily chlorinated water from the storage reservoir from the disinfection process shall be in accordance with Provincial Regulations.

8.5.19 PROVISIONS FOR SAMPLING

Smooth-nosed sampling tap(s) shall be provided to facilitate collection of water samples for both bacteriological and chemical analyses. The sample tap(s) shall be easily accessible.

8.5.20 GEOTECHNICAL

A geotechnical investigation shall be performed by the Developer to determine ground conditions. A geotechnical report will be produced that addresses: the bearing strength of the soil; the reservoir foundations; pipework thrust restraint; access road and settlement issues. The report shall provide details of the investigation including testing, analysis, findings, and recommendations. The report shall be prepared by a Professional Engineer or Geoscientist licensed to practice in the Province of Newfoundland and Labrador.

8.5.21 ACCESS ROAD

The reservoir design shall include an access road design for all-weather access and manoeuvring by operations, maintenance, emergency, and supply vehicles. Access roadways and parking areas shall be trafficable in all weathers. The Right-Of-Way for the access road shall be conveyed to the City at no charge as a condition of approval.

9 LANDSCAPING

An urban forest is defined as the collection of trees, shrubs, other vegetation, and their habitat found within an urbanized area. Through the implementation of long-term planning documents such as St. John's Urban Forest Management Master Plan and Parks and Open Space Master Plan, the City is committed to cultivating an urban forest that is diverse, attractive, and sustainable which builds upon the City's existing network of parks, green spaces, trails, and tree-lined streets.

St. John's has forests and natural areas which extend deep into the City. These forested areas are beautiful. They provide places for recreation and rest from the pressures of urban living. They also contribute to how we manage stormwater runoff. Development enables cities to meet the needs of a growing population. With St. John's' unique growing conditions, slow-growing environment, and limited growing season, we must focus on preserving our existing resources.

9.1 LANDSCAPE DEVELOPMENT POLICY AND STREET TREE PLANTING STANDARDS

Cities such as St. John's are in a constant state of change. Development enables cities to adapt to meet the needs necessary to facilitate such change. It is the role of City staff to guide development based upon the decisions of City Council such that what's deemed best in the public interest is achieved. In this instance staff need to work with the Development community to find a balance between developing natural areas and protecting the functions that natural ecosystems provide.

The City requires that all landscape work in City parks, on municipal lands, or as part of the development process be completed in accordance The Landscape Development Policy. These requirements are applicable to all levels of development proposed within the City of St. John's regardless of size, cost, or level of complexity.

These standards and specifications have been prepared to provide Developers and Contractors with the necessary information including construction details in order to avoid delays and facilitate the approval process, while at the same time ensuring the long-term sustainability of the City's green infrastructure.

Further information regarding this policy and standard can be found on the City of St. John's Website.

9.2 LANDSCAPING REQUIREMENTS

One of the primary ways of achieving the goals outlined in the above documents is working with private Landowners through the City's development review process. In doing so the City aims to ensure that where feasible, existing natural resources and parklands are protected and retained, and that space is provided to support the

successful planting of trees, establishment of landscapes, and development of new park amenities.

9.2.1 RESIDENTIAL DEVELOPMENT

General Landscaping Requirements:

- 1) The existing landscape character shall be preserved, to an extent reasonable and feasible. This includes the preservation of existing trees and incorporation of new trees into the landscape.
- 2) Landscaping shall be as outlined in Section 7.6 of the City of St. John's Development Regulations.
- 3) Apartment buildings shall be landscaped in accordance with Section 7.6 of the City of St. John's Development Regulations and Division 13 of this Manual.
- 4) Street trees (minimum one per lot) shall be situated within a front or side yard, visible from the road, and subject to requirements of the City of St. John's Development Regulations.
- 5) For the duration of their Development Approval, the Developer must ensure any homes constructed within the approved development comply with the approved landscaping plan
- 6) Shrubs, ground cover, and other plant materials shall be used to compliment tree planting they shall not be the sole contributor to the landscape. Effective use of earth berms, existing topography, and existing vegetation is also encouraged as a component of the overall landscape.
- 7) Refer to Section 9.6 for information of individual features e.g., sodding, hydroseeding, soils, tree planting, etc.

9.2.2 NON-RESIDENTIAL DEVELOPMENT

General Landscaping Requirements:

- 1) The existing landscape character shall be preserved to an extent reasonable and feasible. This includes the preservation of existing trees and incorporation of new trees into the landscape.
- 2) Landscaping shall be as outlined in Section 7.6 of the City of St. John's Development Regulations. Except for specific zoning requirements, at least 20% of the Development shall be covered with soft landscaping.
- 3) In addition to zone requirements, apartment buildings shall be landscaped in accordance with Division 13 of this Manual.
- 4) All landscaping adjacent to paved areas shall be protected by concrete curbs, retaining structures or other protective measures.
- 5) Buffering and screening shall be provided in accordance with the City of St. John's Development Regulations.
- 6) Landscaping both at the time of establishment and in future shall not obstruct vehicular sightlines at street intersections, access drives, parking aisles, etc. Nor shall any feature which creates an obstruction of view be located within the sight triangle.

- 7) Trees shall be placed along property frontages subject to the line-of-sight requirements of the City of St. John's Development Regulations and Section 9.6.4 of this Manual.
- 8) Implementing and maintaining landscaping in accordance with approved Landscape Plans is a requirement of the City's Commercial Maintenance By-Law. Where properties do not conform the City may complete the required work to achieve compliance and levy the cost of completing the work against the property Owner as taxes due and owing in respect to the property.
- 9) No tree shall be planted closer than 1.5 m from any driveway, or laneway, nor shall a tree be planted in such a manner that it's eventual growth cannot be maintained, so as to avert interference with or obstruction to any improvements installed for public benefit.
- 10) Refer to Section 9.6 for information of individual features e.g., sodding, hydroseeding, soils, tree planting, etc.

9.3 LAND FOR PUBLIC PURPOSES

St. John's Parks and Open Space Master Plan describes the vision for the City's parks and open spaces network and provides a series of requirements for development to ensure this vision is achieved. Developers must review the requirements for to ensure compliance.

Developers are responsible for identifying existing and proposed green spaces, trails, parks, and their proximity to the proposed Development. Green spaces, trails, and parks must be categorized using the classification system included in the City's Parks and Open Spaces Master Plan.

As outlined in the City of St. John's Development Regulations, Council may require the Owner of the lands forming the Development to convey land to the City for public purpose.

9.3.1 GREEN SPACE CLASSIFICATION

Green spaces have high environmental value within the City and have two classifications.

Greenway

Greenways provide open space connections to and from parks, schools, and neighbourhoods, and may include wildlife corridors, pathways, and trails. Thus, the greenway is a vegetated corridor of land that incorporates pathways or trails.

Natural Space

These are areas of land or water representing distinct elements of an area's geological, ecological, or species diversity, and includes natural landscapes or features of value for natural heritage protection. Although human participation is encouraged in natural spaces, the participation is secondary to space protection.

9.3.2 PARK CLASSIFICATION

Parks are public land specifically designed or reserved for the general public for active or passive recreational use. They include all natural and man-made landscaping, facilities, playing fields, buildings, and other structures that are consistent with the general purpose of public park land. There are six different park classifications.

Neighborhood Park

- Local park, providing easy access to recreation and leisure activities. May include informal court and field play spaces, playground equipment, natural space and access to trails.
- Approximately 1 hectare in size, placed at 20-minute walking intervals (1600 m)

Community Park

- Strategically placed parks designed to meet the needs of several adjacent neighborhoods. This type of park may include formal sport facilities, expanded play areas and are suitable for hosting community events.
- Between 3.2 and 12.1 hectares in size, placed at 40-minute walking intervals (3700 m – no more than 20 minutes from any resident's front door).

Municipal Park

- This is a large, destination park, suitable for a variety of different uses, including festivals and sport tournaments. These sites may include a number of unique features such as: BMX tracks, ice skating trails or rinks, picnic areas, internal walking trails, off-leash dog areas, etc.
- Between 12.1 to 40 ha and above in size, attracting visitors from within a 50 km radius of the site.

Urban Plaza

- Social gathering sites, typical of downtown or large Commercial sites, providing opportunities for social interaction, public markets, and small events.
- Location, size, and use may vary.

Neighborhood Square

- Social focal point for high-density Residential or Institutional areas. Providing opportunities for rest, recreation, or public events.
- Location, size, and use may vary.

Community Common

- This classification refers primarily to existing tot-lots. Where feasible to do so the City will work with local residents to ensure these sites meet the current needs of the surrounding community.

9.3.3 TRAIL CLASSIFICATION

Trail networks are designed and constructed throughout the City to provide connectivity through varied contexts. There are two classification of trails within the City.

Community Trail – Connects neighborhoods and provides access to frequent destinations within the community. These trails may be single-use or multi-modal depending upon the needs of the community. These trails are essential as they often provide connection to the larger Municipal Trail network.

Municipal Trail – Larger, multi-modal trail network that exists throughout the City, providing access to key destinations and support alternative means of transportation.

Applicants must review these requirements and classification descriptions in the context of any proposed Development to ensure compliance.

9.4 BUFFERING & SCREENING

Buffering and screening is to be provided as per the requirements of Section 7.6.3 of the City of St. John's Development Regulations.

9.5 LANDSCAPE PRESERVATION AND PROTECTION

St. John's is fortunate in that it is surrounded by existing forests and natural areas, many of which extend deep into the City. These forested areas are aesthetically pleasing, provide areas for passive recreation and respite from the pressures of urban living, and contribute significantly towards the City's management of stormwater runoff.

St. John's is a slow growing environment, primarily due to its relatively short growing season and other climatic conditions. This requires that additional emphasis be placed on the preservation of existing resources through the course of development.

Where possible existing resources should be preserved and incorporated into the overall site design. Consideration of the retention of trees and other natural resources during the initial phases of the design process can help avoid costly revisions and ensure proper protection measures can be applied.

9.5.1 TREE PROTECTION

Where the proposed Development can cause damage to existing trees, above or below ground tree protection may be required pursuant to an approved Landscaping Plan. Tree protection is applicable to all levels of development proposed within the City, regardless of size, cost, or level of complexity.

Anyone failing to adhere to the Tree protection standards for trees on public land will be financially responsible for resulting damages. Trees on public property are protected under the City of St. John's Act and cannot be removed or damaged without prior authorization from the Department of Public Works Parks Division.

9.5.2 ESTABLISHING A TREE PROTECTION ZONE (TPZ)

The size and location of the required TPZ is as follows:

- A TPZ will be established around each tree within and immediately adjacent to any proposed Development.
- The TPZ will be determined based upon the trunk diameter of the tree in question, multiplied by a factor of six (6). For example, a tree measuring 40 cm in diameter would require a tree protection zone of 2.4 m measured from the base of the tree (40 cm x 6 = 240 cm or 2.4 m). **The minimum required TPZ is 2.4 m.**
- In an area with rows or groupings of trees, a continuous TPZ is preferred rather than individual TPZs.
- Final Approval of the TPZ must be obtained by the City's Public Works Parks division prior to the start of construction.

9.5.3 PROHIBITED ACTIVITIES WITHIN A TPZ

Once a TPZ has been established the following activities are prohibited.

- Excavation;
- Storage of material, refuse or other debris;
- Changes of grade;
- Cutting of tree limbs or roots;
- Dumping of slurries or other liquids;
- Operation of heavy equipment; and
- Entry of vehicular traffic, etc.

Where excavation is in close proximity to existing trees, hand digging, hydrocyanation, or other approved non-invasive methods of excavation may be required in conjunction with root pruning. In these instances, or where minimum TPZs cannot be achieved, individual tree assessments will be required. The individual tree assessment should determine the tree's ability to withstand the proposed work while maintaining structural stability of the tree.

9.5.4 TREE PROTECTION FENCING

Once a TPZ has been established it must be identified by protective fencing and signage. TPZs can be defined using orange snow fencing attached to rebar, t-rails, or similar posts. Signage shall be attached to the fencing identifying the area as a tree protection zone. Where excavation is in close proximity to existing trees, tree protection hoarding is to be used. Tree hoarding is to be constructed of plywood or other rigid material where

necessary to block debris from entering the TPZ. Protective fencing must remain in place through all stages of construction..

9.5.5 TPZ SIGN

Figure 9-1 shows a sample City of St. John's Tree Protection Zone sign. This sign is also available for download on the City's website and may be reproduced for use throughout the City.



Figure 9-1 - Tree Protection Zone Sign - Sample

9.5.6 SNOW STORAGE AND REMOVAL

Snow removal and storage can have a detrimental impact on trees, shrubs, and other vegetation. Through the site design process, consideration must be given to managing snowfall and ensuring appropriate space is provided to satisfy both the City's tree planting and snow removal requirements. Developers are required to describe how snowfall will be managed at the site and identify snow storage areas on Landscape Plans.

To avoid damage during snow removal for Commercial uses, concrete curbs or retaining structures must be provided adjacent to landscaped areas to define boundaries between different site uses and provide an additional level of protection.

9.5.7 RELOCATION OF TREES

The existing landscape character shall be preserved to an extent reasonable and feasible. This includes the preservation of existing trees and incorporation of new trees into the landscape.

Transplanted trees will be considered when calculating landscape requirements.

9.6 LANDSCAPE PLANS

Landscape Plans and associated details are required components of Development applications. Landscape plans for Residential Subdivision Developments and Non-Residential Developments must be prepared by a qualified landscape professional with the requisite skills to interpret construction plans and develop landscape designs that are harmonious with all elements of the proposed Development.

Landscape Plans should be developed in concert with the overall site development process. Engaging the services of a landscape professional early in the project planning stages can help to ensure alignment with City requirements, avoiding costly delays and revisions at a later stage.

9.6.1 GENERAL REQUIREMENTS:

Landscape Plans must include as a minimum the following:

- I. Total calculation of landscaped areas;
- II. Existing vegetation to be removed;
- III. Existing trees to be retained including a tree protection plan;
- IV. Proposed location of trees, flower beds, and planters;
- V. Proposed location of driveways;
- VI. Description and locations of hard landscaping;
- VII. Identify the areas to be sodded or seeded;
- VIII. Tree and shrub planting details, including soil specifications; and
- IX. Snow storage plan.

Trees and shrubs shall be selected in accordance with the Tree Planting Specifications or those species hardy to Canadian Plant Hardiness Zone 5B, salt tolerant, adapted to environmental conditions at the site, with a proven local history.

Trees and shrubs shall meet the most recent Canada Nursery Stock Standards.

Shrubs, ground cover and other plant materials shall be used to complement tree planting but shall not be the sole contributor to the landscape. Effective use of earth berms, existing topography and existing vegetation is also encouraged as a component of the overall Landscape Plan.

In determining the suitability of the proposed landscaping, the Department of Public Works, Parks and Open Spaces Division will consider topographical constraints on design, drainage, access and egress, utilities, and other factors reasonably related to the health, safety, and welfare of the public which necessitated disturbance of the existing natural landscape character.

9.6.2 SPECIES SELECTION

Matching the species to the site is a critical component of developing planting plans. Careful consideration needs to be taken to ensure the characteristics of the tree matches the site conditions. Some of the attributes to be considered include: mature height; crown spread; light requirements; shade tolerance; salt tolerance; present soil type; moisture condition; fruit, flower and seed production; native range; adjacent site uses; future maintenance plans; property user preferences, etc.

Both existing and proposed site conditions must be taken into account when selecting planting locations and choosing species to plant. Items to consider include:

- I. Mature growth – Trees, shrubs and other vegetation will grow. The size of the proposed species must be taken into consideration in the context of the proposed planting location.
- II. Utilities – The presence of utility infrastructure both above and below grade can result in future conflicts, compromising site safety and long-term tree growth.
- III. Snow – On site snow storage must be considered early and throughout the site design process. Snow storage must be provided in a manner that does not conflict with proposed landscaping or cause sightline obstructions.

Trees and shrubs shall be species hardy to Canadian Plant Hardiness Zone 5B, salt tolerant, adapted to environmental conditions at the site, with a proven local history.

9.6.2.1 SPECIES DIVERSITY

In line with the City's goal to improve the health and resiliency of St. John's natural environment, species diversity is encouraged. No single tree species shall represent more than 25% of the total number of trees proposed within a Development. Exclusions may be considered to accommodate specific landscape designs e.g., reforestation plantings, historical features, subject to the approval from the Municipal Arborist.

Species diversity considerations should not be limited to the immediate site in question. Designers also need to be mindful of the species composition of surrounding properties and beyond.

9.6.2.2 STOCK SIZE

The following stock sizes have been identified as minimums required for Residential and Non-Residential sites:

- Residential
 - Deciduous – 40 mm Caliper

- Coniferous – 100 cm High
- Non-Residential
 - Deciduous – 50 mm Caliper
 - Coniferous – 150 cm High

Existing site conditions present many challenges for trees. Choosing the right size of stock can help provide an immediate site impact and resistance to environmental threats such as snow clearing, lawn and other landscape maintenance work, vandalism, or vehicular damage.

9.6.3 TREE PLANTING REQUIREMENTS

Tree planting is a required component for all developments. Tree planting plans are to be identified on a Landscape Plan prepared by a qualified professional. Further details regarding the requirements of a Landscape Plan are included in the City's Landscape Development Policy.

9.6.4 TREE PLANTING LOCATION & SPACING

Residential

Street trees (minimum one per lot) shall be situated within a front or side yard visible from the road, subject to line-of-sight requirements of the City of St. John's Development Regulations.

Non-Residential

Trees shall be placed along property frontages subject to the line-of-sight requirements of the City of St. John's Development Regulations planted along street frontages shall be situated a maximum of 8 m on centre, at a minimum frequency of one tree per 8 m of lot frontage. Wider spacing may be accommodated at specific locations to enable the safe use of a street, sidewalk, to accommodate snow clearing, or to facilitate other intended site usages. Tree planting density, however, may not be reduced.

No tree shall be planted closer than 1.5 m from any driveway, or laneway, nor shall a tree be planted in such a manner that its eventual growth cannot be maintained, so as to avert interference with or obstruction to any improvements installed for public benefit.

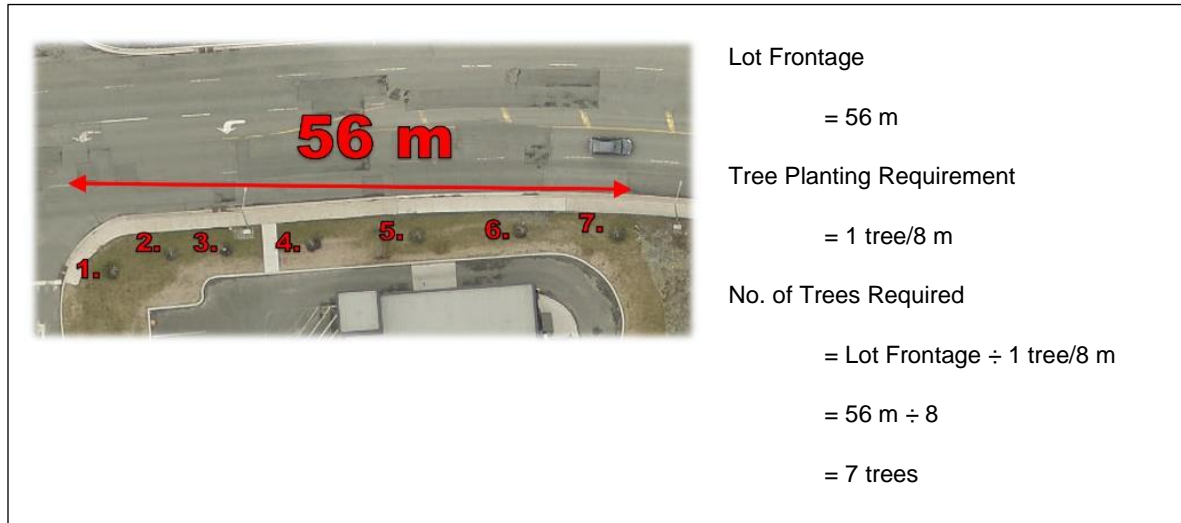

Figure 9-2 - Non-Residential Tree Planting Example

9.6.5 TREE PLANTING DETAILS AND SPECIFICATIONS

The City of St. John's tree planting detail has been developed to provide consistent direction with respect to tree planting. The detail is applicable to both coniferous and deciduous trees of varying root stock conditions and can be applied to most tree planting applications. A copy of this detail is below in Figure 9-3.

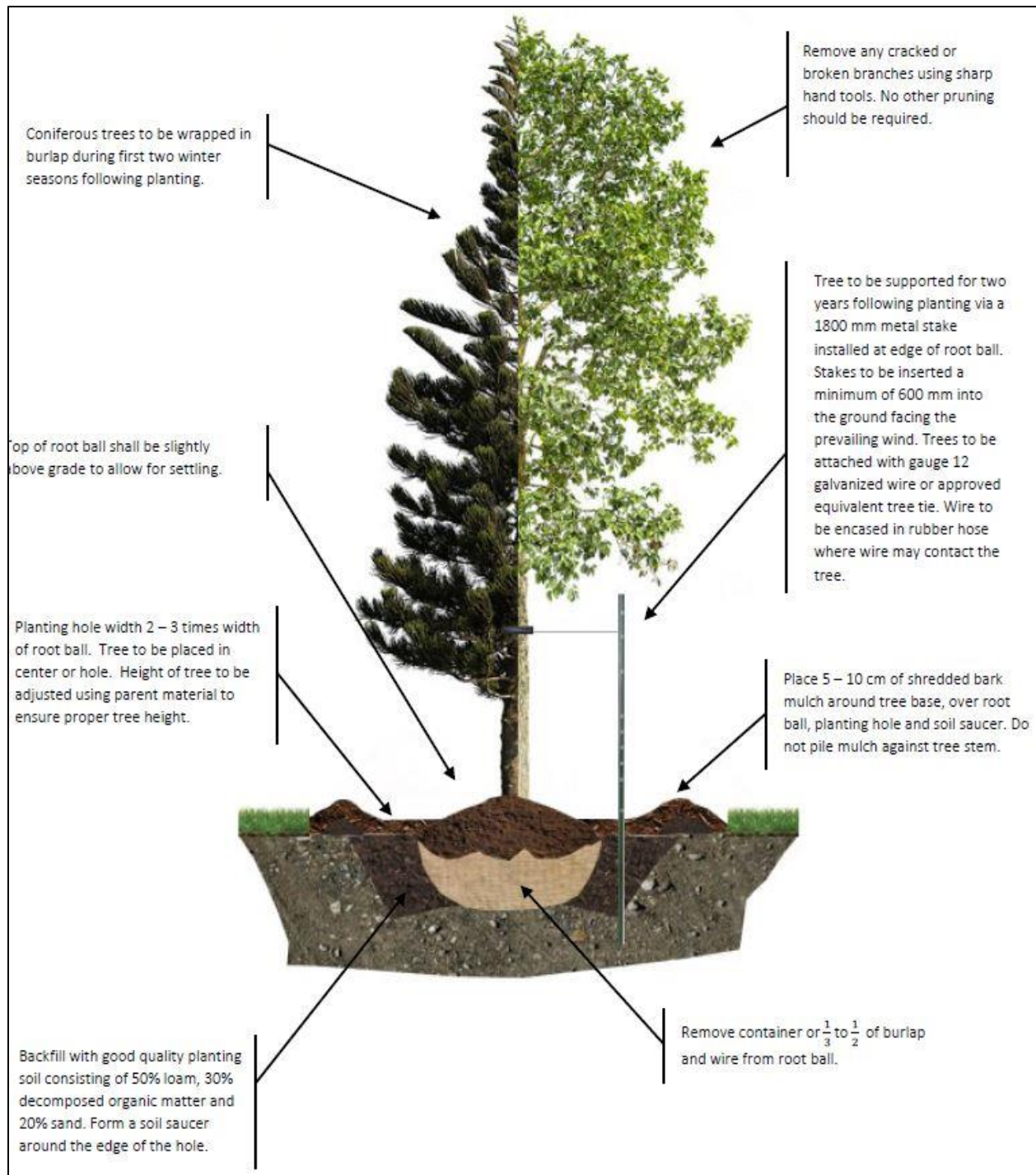

Figure 9-3 - Tree Planting Detail

9.6.5.1 SOIL COMPOSITION

Trees need access to good quality soil that provides an abundant source of moisture and nutrients to survive. Construction sites are typically heavily disturbed areas comprised of compacted soil with low nutrient value. Where possible, existing soil should be preserved and set aside for use toward the later stages of construction.

Where this is not possible, it'll likely be necessary to supply new soil. Doing so with a mixture consisting of 50% loam, 30% decomposed organic matter and 20% sand will help to ensure planting success.

9.6.5.2 SOIL VOLUME

In addition to getting the correct soil composition, it's equally important to ensure trees are provided with an adequate amount of soil to ensure the site provides the requirements necessary to achieve mature growth.

Trees shall be planted in good quality soil consisting of 50% loam, 30% decomposed organic matter and 20% sand.

Cultivated soil to provide for a minimum porous root zone of 1.25 m³ (1.25 m width, 1.25 m length and 0.80 m depth) to enable normal root development and tree establishment. In the instance that these specifications conflict with the City's tree planting detail, the tree planting detail shall prevail.

9.6.5.3 STAKING

Trees are to be supported during the first two years following planting via stakes installed at the edge of the root ball. Stakes are to be inserted a minimum of 600 mm into the ground facing the prevailing wind. Trees are to be attached with gauge twelve galvanized wire or approved equivalent tree ties. Wire to be encased in rubber hose where wire may contact the tree. Coniferous trees are to be wrapped in burlap during the first two winter seasons following planting.

9.6.5.4 ESTABLISHMENT

Tree planting and other landscaping must be completed prior to the issuance of a Final Occupancy permit. In instances where this is not possible, approval may be granted subject to the Property Owner agreeing to complete the approved work per the following schedule:

- I. Outstanding work identified by September 30th must be completed within 60 days.
- II. Outstanding work noted after September 30th, must be completed by June 30th of the following year.

It's important to note that in accordance with the City of St. John's Commercial Maintenance By-Law Property Owners are responsible for maintaining all landscaping in accordance with approved plans in perpetuity. Where properties do not conform with the By-Law, the City may complete the required work to achieve compliance and levy the cost of completing the work against the Property Owner as taxes due and owing in respect to the property. Therefore, it is essential to ensure that the proposed landscaping is well suited for the intended site.

9.6.6 TOPSOIL, SODDING, AND HYDROSEEDING

In addition to the technical content included in the Landscape Development Policy, further details are included with respect to the provision of topsoil, sodding and hydroseeding in the City of St. John's Specification Book. A copy of this document is included on the City's website. Pertinent items include:

- I. Topsoil must have a pH level of 6.8 and be free of roots, vegetation, debris and stone greater than 40 mm in diameter.
- II. There are four different grades of sod:
 - Premium;
 - Standard;
 - Specialty; and
 - Field.
- III. In addition to identifying the grade of sod required, Property Owners may also be required to provide sod with a certain growing medium, e.g. mineral, soil, peat, sand, etc.
- IV. When using seed, seed must be Certified Canada No. 1, have a minimum germination rate of 75% and in the absence of specifying a unique blend, include the following mixture:
 - 50-60% Kentucky blue grass;
 - 20-30% creeping red fescue; and
 - 10-20% perennial rye.
- V. It is important to note that any sod, hydroseed or other turf installation placed in the fall will not be accepted until the following June when it can be determined whether or not the vegetation has established and will survive.
- VI. Topsoil or turf grass shall not be placed prior to May 1st or after November 1st.

9.7 VEGETATION GRADIENTS

Vegetation gradients refer to vegetation transitions found along the vertical axis of any sized drainage area; whether it is regional or site scale. When referring to a wet pond or engineered wetland system with characteristic fluctuating water levels, vegetation gradients can be in flux during a prolonged establishment period due in part to a cycle of sediment deposition, re-suspension, and subsequent deposition. The significance of this is the need for consideration when designing vegetation gradients. With most natural wet pond and wetland systems, there is constant vegetation gradient fluctuation, typically with ample horizontal space. This in mind, the difference between a true wet pond or wetland, and the wet pond or engineered wetland systems proposed is that the horizontal space is fixed. Design implications of this include the need for wet pond or wetland wall slopes to accommodate not only safety aspects, but as well fixed spatial

sediment deposition cycles, and the need to facilitate changing vegetation gradients. The design of variable vegetation gradients necessitates the need to provide adequate overlap of vegetation types.

This Manual defines five hydrologic/vegetation gradients present within a wet pond or wetland: i). Deep Water areas, ii). Shallow Water areas, iii). Shoreline Fringe Areas, iv). Flood Fringe areas, and v). Upland areas. The following describes the conditions present in each and introduces vegetation types applicable for each. Refer to Table 9-1 for appropriate species used within each gradient.

9.7.1 DEEP WATER AREAS

The majority of an area in a wet pond and some areas of an engineered wetland are comprised of deep water areas. Plantings in deep water areas are restricted to *aquatic vegetation*. The transition between shallow and deep water plantings will eventually establish itself according to water level fluctuations, sediment deposition cycles, and light availability.

9.7.2 SHALLOW WATER AREAS

Shallow water areas, the aquatic bench, are considered to be the areas of the permanent pool where the depth is 0.5 meters or less. This is typically defined as the perimeter of the pond or wetland. Plantings in shallow water areas include both *aquatic* and *emergent vegetation*. *Aquatic* plant species shall be planted at water depths between 0.3 m and 0.5 m. *Emergent* plant species shall be planted at water depths at 0.3 m. The wet pond wall side slopes will determine the amount of vegetation that can be established. The selection of plant species shall consider nutrient uptake (for absorbing excess nitrates conveyed with first-flush stormwater), stormwater filtration, safety, and aesthetics. Other benefits of *emergent* vegetation include the prevention of re-suspension of bottom sediments and the reduction of flow velocities to aid in sedimentation.

9.7.3 SHORELINE FRINGE AREAS

Shoreline fringe areas are the areas subject to frequent wetting from storm events. In general, this is the gradient delineated between the PWL (permanent water level) and HWL (high water level) for erosion/water quality control. This area will typically have higher soil moisture conditions during the frequent storm events. The area close to the NWL (normal water level) elevation is subject to more frequent flooding and wave action from the pond. This area must be adequately protected from erosion. Plantings in shoreline fringe areas include both *emergent* and *hydric vegetation*. Due to the frequency of inundation, plant stocks should be used instead of seed.

9.7.4 FLOOD FRINGE AREAS

When the wet pond or engineered wetland is used to control peak flow rates, a zone of infrequent inundation is created. This gradient is referred to as the flood fringe area and is generally the area slightly below or above the HWL (high water level). Plantings in the flood fringe area include transitional *hydric* species and a mix of grass, perennial, and shrub species. In addition, deterrent vegetation (species which discourage access either by species characteristics and/or density) may be planted to provide safety measures as an alternative to fencing. Together with upland plantings, an effective barrier to public entry can be obtained.

9.7.5 UPLAND AREAS

Upland areas are landscaped areas above the HWL (high water level) that provide aesthetic and passive recreation amenities around the pond or wetland. Plant species shall be chosen to restrict access to steep areas or inlet/outlet locations.

A minimum horizontal buffer strip of 15 meters shall be provided outside of the HWL. Any formal pathways to be incorporated must be constructed above the 100-year elevation (HWL). Pathway locations and design shall also consider the protection of any native habitats created or protected. Any deviations require approval of the City.

Table 9-1 - Vegetation for Wet Ponds and Engineered Wetlands





Name	Aquatic	Emergent	Hydric	Upland	Image
Nuphar lutea (Yellow Water Lily)	•				
Potamogeton natans (Floating Pondweed)	•				
Potamogeton pectinatus (Sago Pondweed)	•				
Sparganium chlorocarpum (Green-Fruited Bur-Reed)	•				
Sparganium erectum (Simple-Stem Bur-Reed)	•				
Sparganium eurycarpum (Giant Bur-Reed)	•				

Table 9-1 – Vegetation for Wet Ponds and Engineered Wetlands (Cont'd)



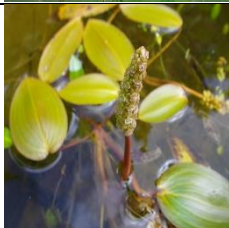



Name	Aquatic	Emergent	Hydric	Upland	Image
Carex aquitilis Walenb. (Water Sedge)	•	•			
Carex crinite (Fringed Sedge)	•	•			
Carex lacustris (Lake Sedge)	•	•			
Carex pseudocyperus (Cypress Sedge)	•	•			
Eleocharis palustris (Creeping Spike Rush)	•	•			
Juncus articulatus (Jointleaf Rush)	•	•			

Table 9-1 – Vegetation for Wet Ponds and Engineered Wetlands (Cont'd)







Name	Aquatic	Emergent	Hydric	Upland	Image
Juncus Canadensis (Canada Rush)	•	•			
Juncus effusus (Soft Rush)	•	•			
Sagittaria latifolia (Broadleaf Arrowhead)	•	•			
Schoenoplectus acutus (Hardstem Bulrush)	•	•			
Schoenoplectus tabernaemontani (Softstem Bulrush)	•	•			
Scirpus sp. (Bulrush)	•	•			

Table 9-1 – Vegetation for Wet Ponds and Engineered Wetlands (Cont'd)







Name	Aquatic	Emergent	Hydric	Upland	Image
Utricularia vulgaris (Bladderwort)	•	•			
Acorus americanus (American Sweetflag)		•	•		
Juncus tenuis (Path Rush)		•	•		
Carex arctata (Drooping Wood Sedge)		•	•		
Carex hystericina (Porcupine Sedge)		•	•		
Aster nemoralis (Bog Aster)		•	•		

Table 9-1 – Vegetation for Wet Ponds and Engineered Wetlands (Cont'd)





Name	Aquatic	Emergent	Hydric	Upland	Image
Symphyotrichum puniceum (Purplestem Aster)		•	•		
Caltha palustris (Marsh Marigold)		•	•		
Chelone glabra (Turtlehead)		•	•		
Eriophorum virginicum (Cottongrass)		•	•		
Iris versicolor (Blue Flag)		•	•		
Osmunda regalis (Royal Fern)		•	•		

Table 9-1 – Vegetation for Wet Ponds and Engineered Wetlands (Cont'd)





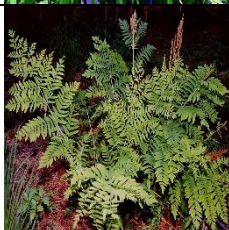

Name	Aquatic	Emergent	Hydric	Upland	Image
Thalictrum aquilegifolium (Meadow Rue)		•	•		
Viola sp. (Violet)		•	•		
Betula pumilla (Bog Birch)		•	•		
Salix bebbiana (Beaked Willow)		•	•		
Salix glauca (White Willow)		•	•		
Salix lucida (Shining Willow)		•	•		

Table 9-1 – Vegetation for Wet Ponds and Engineered Wetlands (Cont'd)







Name	Aquatic	Emergent	Hydric	Upland	Image
Spirea latifolia (Meadowsweet)		•	•		
Salix discolor (Pussy Willow)		•	•	•	
Calamagrostis canadensis (Bluejoint)			•		
Eupatorium maculatum (Spotted Joe Pye Weed)			•		
Geum rivale (Water Avens)			•		
Sanguisorba Canadensis (Canada Burnet)			•		

Table 9-1 – Vegetation for Wet Ponds and Engineered Wetlands (Cont'd)







Name	Aquatic	Emergent	Hydric	Upland	Image
Solidago rugosa (Rough-stemmed Goldenrod)			•		
Andromeda glaucophylla (Bog Rosemary)			•		
Chamaedaphne calyculata (Leatherleaf)			•		
Kalmia polifolia (Bog Laurel)			•		
Ledum groenlandicum (Labrador Tea)			•		
Asclepias syriaca (Milkweed)			•	•	

Table 9-1 – Vegetation for Wet Ponds and Engineered Wetlands (Cont'd)







Name	Aquatic	Emergent	Hydric	Upland	Image
Deschampsia caespitosa (Tufted Hairgrass)			•	•	
Glyceria Canadensis (Rattlesnake Mannagrass)			•	•	
Matteuchia struthiopteris (Ostrich Fern)			•	•	
Osmunda cinnamomea (Cinnamon Fern)			•	•	
Osmunda claytoniana (Interrupted Fern)			•	•	
Solidago macrophylla (Large-leaved Goldenrod)			•	•	

Table 9-1 – Vegetation for Wet Ponds and Engineered Wetlands (Cont'd)







Name	Aquatic	Emergent	Hydric	Upland	Image
Abies balsamea (Balsam Fir)			•	•	
Acer rubrum (Red Maple)			•	•	
Acer spicatum (Mountain Maple)			•	•	
Alnus crispa (Green Alder)			•	•	
Alnus rugosa (Speckled Alder)			•	•	
Amelanchier alnifolia (Saskatoon Serviceberry)			•	•	

Table 9-1 – Vegetation for Wet Ponds and Engineered Wetlands (Cont'd)







Name	Aquatic	Emergent	Hydric	Upland	Image
Amelanchier canadensis (Shad-blow Serviceberry)			•	•	
Aronia melonocarpa (Black Chokeberry)			•	•	
Betula alleghaniensis (Yellow Birch)			•	•	
Cornus alternifolia (Pagoda Dogwood)			•	•	
Cornus racemosa (Gray Dogwood)			•	•	
Cornus sericea (Red Twig Dogwood)			•	•	

Table 9-1 – Vegetation for Wet Ponds and Engineered Wetlands (Cont'd)







Name	Aquatic	Emergent	Hydric	Upland	Image
Cornus stolonifera (Red-Osier Dogwood)			•	•	
Kalmia angustifolia (Sheep Laurel)			•	•	
Larix laricina (American Larch)			•	•	
Prunus pennsylvanica (Pin Cherry)			•	•	
Prunus virginiana (Chokecherry)			•	•	
Rhododendron canadense (Rhodora)			•	•	

Table 9-1 – Vegetation for Wet Ponds and Engineered Wetlands (Cont'd)









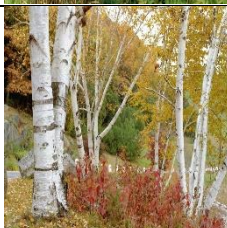

Name	Aquatic	Emergent	Hydric	Upland	Image
Rudbeckia hirta (Black-Eyed Susan)				•	
Schizachyrium scoparium (Little Bluestem)				•	
Solidago canadensis (Canada Goldenrod)				•	
Betula papyrifera (Paper Birch)				•	
Juniperus communis (Common Juniper)				•	
Juniperus horizontalis (Creeping Juniper)				•	

Table 9-1 – Vegetation for Wet Ponds and Engineered Wetlands (Cont'd)

Name	Aquatic	Emergent	Hydric	Upland	Image
Picea glauca (White Spruce)				•	
Potentilla fruticose (Shrubby Cinquefoil)				•	
Sambucus racemosa (Red Elderberry)				•	
Viburnum cassinoides (Northern Wild Raisin)				•	
Viburnum trilobum (American Cranberrybush)				•	

10 EROSION AND SEDIMENT CONTROL

The purpose of this Division of the Manual is to provide design guidance for temporary and permanent erosion prevention, sediment control, and the control of other development activities that cause pollution during the construction process.

An Erosion and Sediment Control Plan (ESCP) is required for any ground-disturbing operation that exceeds 100 m² and that requires a building or development permit.

10.1 EROSION AND SEDIMENT CONTROL PLAN

The ESCP shall be prepared by a licensed Professional Engineer with experience in erosion and sediment control. The ESCP shall be submitted to the City for review prior to any ground disturbance.

The ESCP shall, at a minimum:

- Identify any watercourses, water bodies, floodplains, wetlands, or outfalls in close proximity to the ground-disturbing activity.
- Delineate the boundaries of the area to be disturbed and indicate the numeric value of the hectares that will be impacted.
- Indicate existing and proposed elevations. Drainage patterns for existing and final ground contours shall be provided.
- Indicate all proposed drainage controls
- Provide a general construction schedule for the proposed work including the anticipated start and completion dates for all ground-disturbing activities. Additionally, provide the associated dates for the installation and removal of all erosion and sediment Best Management Practices (BMPs).
- Show the location of all erosion and sediment BMPs and their position relative to the ground-disturbing activities.
- Identify development activities/areas with the potential to generate pollutants such as: vehicle fueling, trash collection, topsoil and other material stockpiles, dewatering discharge, etc.
- For all structural erosion and sediment control BMPs, provide a detail of installation methods including any sizing calculations (flow volumes, rates, etc.).
- When required, provide drainage computations.

10.2 RECOMMENDED BMPS

Erosion control is implemented at the source where erosion occurs or is predicted to occur. Conversely, sediment control is implemented some distance from the source.

10.2.1 EROSION CONTROL

Some common erosion control BMPs are:

- I. Surface roughening;
- II. Temporary grasses and permanent vegetative cover;
- III. Mulch;
- IV. Erosion Control Blankets;
- V. Plastic Sheet Covering;
- VI. Dust Control;
- VII. Armoring;
- VIII. Live Stakes; and
- IX. Live Fascines.

Each of these are described in the following sections.

10.2.1.1 SURFACE ROUGHENING

Surface roughening involves the creation of ridges, furrows, or terraces in the soil surface, running perpendicular to the natural direction of runoff, in order to slow runoff. See Figure 10-1. This is a permanent site feature as it is not removed at the end of the project.

Roughened soil surfaces shall be seeded and mulched as soon as possible. If conditions are not appropriate for seeding then the area shall be mulched or covered with an erosion control blanket.

Developer shall avoid excessive compaction of soils in order to promote infiltration.



Figure 10-1 - Surface Roughening Through Terracing

10.2.1.2 TEMPORARY GRASSES AND PERMANENT VEGETATIVE COVER

Temporary grasses are planted prior to construction activities to control erosion. This BMP is replaced at the end of the project with a permanent vegetative cover, see Figure 10-2.

Native grasses are recommended for erosion control. Ryegrass and non-native clover species are not recommended because of their invasiveness.

Temporary grass cover shall be fully established by October 1 or mulches and erosion control blankets may be temporarily required until appropriate grass coverage is achieved. Seeding and mulching shall be done by September 1.

Seeding mixes shall be selected with a 14 day germination period using quick-growing, sterile grasses and grains. Hydroseeding is acceptable.



Figure 10-2 - Temporary Grass and Permanent Vegetative Cover

Mulch shall be composted or straw mulch applied at double the City's hydroseed application requirement. The mulch shall be anchored by working in using rollers or cleat tracks on slopes greater than 3H:1V.

On slopes steeper than 10H:1V, hydroseed and mulch shall be applied with a bonding agent. Erosion control blankets or biodegradable netting may be used instead of a bonding agent.

10.2.1.3 MULCH

Mulch can be organic, natural inorganic, or synthetic material which is spread or blown on the soil surface to prevent erosion, see Figure 10-3.

Mulch on slopes greater than 3H:1V shall require erosion blankets or netting on top of the mulch.

Straw shall not be used by itself as a permanent erosion control practice.

All mulch materials shall be loose and free of significant sediment loads. Straw shall be certified weed-free. Mulches such as compost are ideal because they provide additional plant support nutritional value and soil structure.

Mulches shall be spread uniformly throughout the area and may be integrated into the top layer of soil, if required.

Mulches are most effective when anchored – especially organic mulches. Anchoring can include punching materials into the soil, mixing mulches with bonding agents, or combining mulches with erosion blankets and netting.



Figure 10-3 - Mulch

Grade and roughen the soil surface prior to mulch placement. Ensure a minimum 50mm thickness of mulch across the site and increase the mulch thickness to 150mm on steeper slopes.

10.2.1.4 EROSION CONTROL BLANKETS

Erosion control blankets are mats composed of organic fibers or inorganic material bounded in a biodegradable matrix, see Figure 10-4.

They are used to line open channels, steep slopes, and as supplements to seed and/or mulch treatment.

Erosion control blankets shall be installed in accordance with the Manufacturer's recommendations.

They can be installed with fiber rolls or other barriers at various locations to break the energy of runoff on sloped surfaces.

Seed can be added under and over the mat installations to promote vegetative cover.



Figure 10-4 - Erosion Control Blanket

10.2.1.5 PLASTIC SHEET COVERING

Temporary plastic sheets are placed on the ground surface or on stockpiles to prevent water infiltration and erosion by wind or water. Applicable for small areas where the time of year does not allow other techniques or steep slopes or soil conditions require alternative measures. Plastic sheeting shall always be used with appropriate trenching and conveyance of runoff to an approved disposal point. Plastic sheeting shall be polyethylene with a minimum 6mil thickness. Sheeting shall have 300 mm overlaps at the seams which shall be taped, welded, or weighted down.



Figure 10-5 - Plastic Sheetting

10.2.1.6 DUST CONTROL

Dust control involves several methods and materials to prevent erosion of dry soils. In particular, unpaved roads, stockpiles, and debris. Some dust control methods are:

- I. Tilling soils into large clumps to reduce fines;
- II. Stabilizing roads and parking areas with gravel surfaces over geotextile fabric;
- III. Vegetative barriers and perimeter tree preservation;
- IV. Street sweeping;
- V. Covering stockpiles with plastic sheeting;
- VI. Placement of water on dry soils to resist wind erosion;
- VII. Chemical applications for dust control, see Figure 10-6.



Figure 10-6 - Dust Control

10.2.1.7 ARMORING

Armoring BMPs are usually permanent measures such as: gabions, riprap, turf reinforced mats, etc. They provide erosion protection and stabilization for outfalls, slopes, streambanks, etc. See Figure 10-7 and Figure 10-8.



Figure 10-7 - Gabions



Figure 10-8 - Riprap

10.2.1.8 LIVE STAKES

Live stakes are stakes of woody plant material that take root with relative ease, see Figure 10-9. The cuttings are cut to length, tamped into the ground and then grow into mature shrubs. They are effective and inexpensive for securing natural geotextiles such as jute netting, coir, or other blanket surface treatment. Over time they will stabilize soils and restore riparian zones but they offer no immediate erosion control.

They are typically applied in streambank restorations and shallow slope stabilization



Figure 10-9 - Live Stakes

Slopes shall be 2H:1V or flatter. Ensure that soils are moist before planting and water plants after installation.

Use fresh, healthy, straight and live wood that is at least one year old, with side branches removed and bark on straight section intact. Willows or other native species shall be used.

Prepare 13 mm to 50 mm diameter and 900 mm long cuttings. Cut the ends, that will penetrate the ground on an angle and cut the top square to facilitate tamping. Soak cuttings for 24 hours before installation.

Tamp cuttings into the ground at right angles to the slope and angled downstream. Tamp cuttings into the ground carefully for approximately 80% of their length. Install live stakes in a random configuration approximately 1 m apart.

10.2.1.9 LIVE FASCINES



Figure 10-10 - Live Fascines

Live fascines are bundles of live cut branches of wetland or stream-side materials – usually willow or dogwood species. These bundles are placed into trenches along the streambank and grow out perpendicular to the bank providing vegetative cover and root structure to stabilize the banks.

They are applicable for streambanks that require immediate erosion protection and revegetation.

Prepare the slope by grading back to a 3H:1V or flatter slope. Ensure the soils are moist and the plants are watered after installation.

Assemble live fascines using fresh plant cuttings with alternating basal ends. Live fascine bundles are 150 mm in diameter and tied securely with twine every 300 mm. Install live fascines shallowly to follow the contour of the banks, with a face length of 5 m or less to prevent ground disturbance. Install live fascines in shallow trenches that are a shovel deep and a shovel wide. Install about 1 m apart.

Use survey pegs or live stakes to anchor the live fascine bundles. Place soil along the sides of the live fascines in and around the branches and at each stake to provide growth media. Foot compact all soil.

10.2.2 SEDIMENT CONTROL

Some common sediment control BMPs are:

- I. Sidewalk subgrade barriers;

- II. Temporary sediment silt fences;
- III. Filtration bags and socks;
- IV. Fiber rolls and wattles;
- V. Vegetated buffers;
- VI. Storm drain inlet protection; and
- VII. Filtration berms.

Each of these are described in the following sections.

10.2.2.1 SIDEWALK SUBGRADE BARRIER

Transportation of sediment from a construction site is minimized by using the sidewalk subgrade gravel and the street curb as a temporary trap for sediment-laden runoff.

Applicable for single lot sites where the site slope is equal to or less than 5 percent.

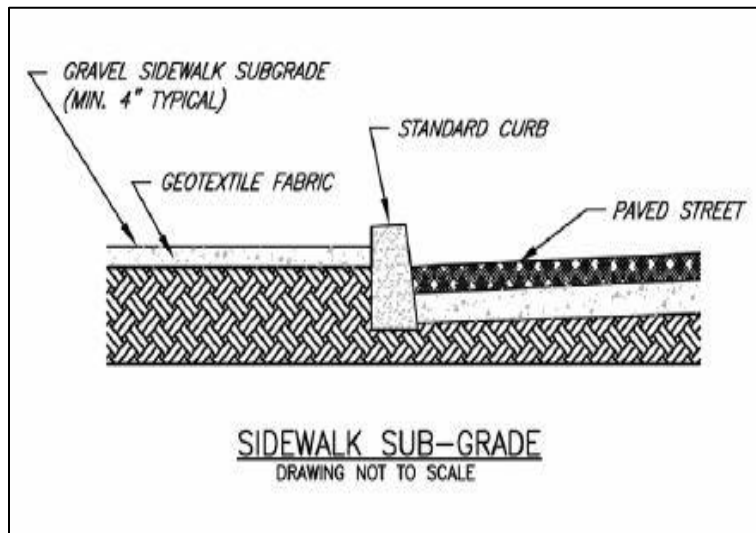

Figure 10-11 - Temporary Gravel Barrier Behind Curb

10.2.2.2 SILT FENCE

A temporary physical barrier to sediment movement and velocity reduction. Silt fences are located: downstream of the disturbed area where runoff occurs as sheet flow; at the toe of soil stockpiles; at intervals along the contours of large, disturbed areas; and at grade breaks.

Silt fences shall not be used: on slopes greater than 2H:1V; across streams or other drainage channels; on paved surfaces; or upslope of disturbance area.



Figure 10-12 - Silt Fence

A trench shall be cut along slope contours and around stockpiles for silt fence installation. Filter fabric fence shall have a minimum vertical bury of 150 mm. All excavated material from the filter fabric fence installation shall be firmly redeposited along the entire trenched area on the uphill side of and against the fence.

Standard or heavy-duty filter fabric fence shall have manufactured stitched loops to fit 50 mm x 50 mm installation posts. Stapled fence products are not permitted. Stitched loops shall be installed on the uphill side of the sloped area, with posts spaced a maximum of 2 m apart.

Where practical, the filter fabric shall be purchased in a continuous roll the length of the barrier to avoid use of joints. When joints are necessary, 50mm x 50mm posts shall be interlocked with each other and attached securely together.

Maximum sheet or overland flow path length to a silt fence shall be 30 meters for slopes greater than 2H:1V and 15m for 2H:1V slopes. The size of the drainage area shall be no more than 0.1 hectares for each 30 lineal meters of silt fence. Ends of the silt fence shall be angled upslope in an arcing fashion.

11 WINTER DESIGN

This Division of the Manual outlines the general winter design requirements for new Commercial, Industrial, and Residential developments. These criteria will allow the City to effectively manage snow clearing and storage operations that support the Development.

11.1 SNOW CLEARING

11.1.1 INTRODUCTION

Snow clearing must be taken into consideration whenever new or temporary roads are proposed for the City to operate and maintain. While the following requirements are not significant, they are vital in minimizing the burden on the City's operational resources.

11.1.2 STUB STREETS

The City recognizes that large developments may be constructed over multiple phases, and this requires the installation of stub streets at future intersections. This can be accommodated, however no building lots shall be included in the stub street unless a temporary cul-de-sac bulb is also installed with the stub street. In addition to this, no driveways will be permitted off the stub street without a temporary cul-de-sac bulb. Stub streets without temporary bulbs must be blocked off during the winter months with concrete jersey barriers, until the street is extended in the next phase of development.

11.1.3 SNOW CLEARING PATH

A plan showing the snow clearing path need not be submitted to the City for review, however Developers must take this into consideration when laying out building lots for Residential, Commercial, or Industrial Development. All proposed building lots shall have access points that are within the snow clearing path to avoid additional passes with snow clearing equipment.

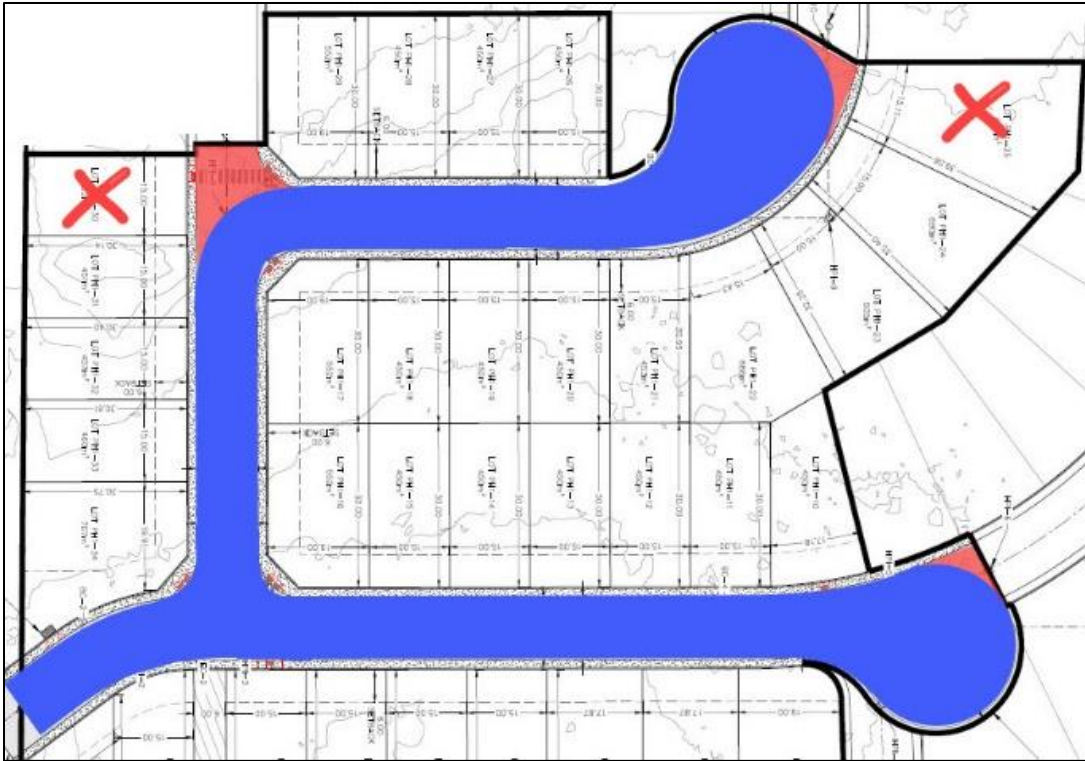

Figure 11-1 - Snow Clearing Path and Driveway Access

Note: The two lots indicated with red Xs are outside the snow clearing path shown in blue.

11.1.4 CUL-DE-SACS

Cul-de-sacs are difficult for operational staff to maintain, not only because snow storage space tends to be reduced, but also because the location of the curb is not easily identifiable by Operators during snow clearing operations. Snow clearing Operators tend to ride along the face of curb with their blade. Cul-de-sacs that are offset to the right are challenging as the curb quickly extends away to the right, which can result with some areas getting left unplowed.

Cul-de-sacs shall be avoided where possible, particularly cul-de-sacs that are offset to the right. The City, in its sole discretion, may limit or eliminate proposed cul-de-sacs within a given Development.

11.1.5 TEMPORARY ROADS

Temporary roads, typically installed for emergency access, will require snow clearing vehicle access. While they may not be installed at the same width as a permanent roadway, they must have the appropriate turning radii along the roadway and at the access points to accommodate large snow clearing equipment. This would typically be a 35 m minimum radius along the roadway, and a minimum radius of 12 m on the center of the vehicle path.

11.2 SNOW STORAGE

11.2.1 INTRODUCTION

As development within the City continues to spread into higher elevations, and further from the City core, the City's operations staff continue to face ever-increasing challenges with snow clearing. Higher snow volumes exist at these higher elevations and costly snow removals can be avoided with proper planning and design. New developments will be expected to provide adequate landscaped areas adjacent to the City roadway, which will provide City operations staff adequate snow storage for snow cleared from City streets. In some circumstances the City may require regional snow storage sites to be designed as a component of a Development.

11.2.2 SNOW ACCUMULATION

The Average Annual Snowfall (AAS) in the St. John's Metro Region tends to vary depending on elevation. Snowfall data from Environment and Climate Change Canada taken from various locations within the City shows the relationship between AAS and elevation can be represented by the following formula:

$$AAS = \frac{E + 195}{100} \quad (11.1)$$

Where:

AAS = Average Annual Snowfall, in meters.

E = Elevation, in meters.

The Snow Accumulation (SA) for design purposes is directly proportional to the AAS. It can be represented by the following formula:

$$SA = S * M * C * AAS \quad (11.2)$$

Where:

SA = Snow Accumulation for design purposes, in meters

S = Safety Factor. The maximum annual snowfall amount experienced in the past twenty years was approximately double the average annual snowfall amount. A value of 2 is used for safety factor.

M = Melting Factor. Due to the City's temperate marine climate, a significant amount of rain and melt situations tend to occur during the winter season. Only a fraction of the total snowfall experienced remains on the ground as snowfall accumulation. A value of 1/3 is used for melting factor.

C = Compaction Factor. Freshly fallen snow compacts once plowed or blown and stored in piles. Sources indicate that compacted snow is approximately three times as dense as freshly fallen snow. A value of 1/3 is used for a compaction factor.

Simplifying the equation for Snow Accumulation yields the equation $SA = \frac{2}{9} \times AAS$, where snow accumulation is in meters, or m^3/m^2 . Further simplifying the relationship between AAS and SA yields the equation:

$$SA = \frac{E + 195}{450} \quad (11.3)$$

Where:

SA = Snow Accumulation, in meters or cubic meters per square meter (m^3/m^2)

E = Elevation of the site in meters. For a Commercial or Industrial development, the average elevation of the site shall be used. To keep calculations simple, the midrange value (average of highest elevation and lowest elevation) may be used for this value.

11.2.3 PLACEMENT OF STORED SNOW

11.2.3.1 SNOW PILE GEOMETRY

Snow typically piles up at a 1:1 slope. This results with snow piles of different polyhedral shapes, dependent on the shape of their base. A curved area would store snow in a conical shape, while a square area would store snow in more of a pyramidal shape. A rectangular shaped base, which is often the case along the side of a roadway, would store snow in a polyhedron that might be more commonly recognized as the shape of a hipped roof.

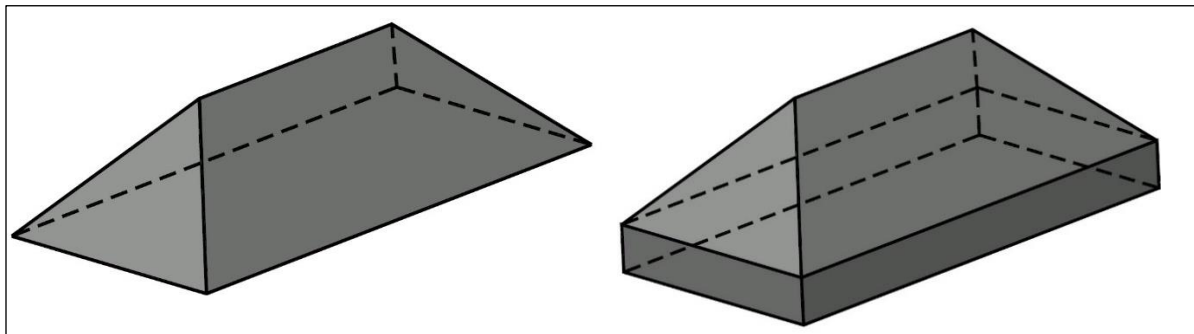

Figure 11-2 - Snow Pile Geometry

During blowback operations, snow blowers would typically cut into the edge of this prism, resulting in a shear face up to 1.2 m high.



Figure 11-3 - Snowblower Blowback

Snow storage piles shall be shown in the appropriate polyhedral shape depending on the geometry of its base, with all sides shown at a 1:1 slope. Sheer faces along the *accessible* perimeter of a snow storage pile may be shown to accurately portray how snow is often stored, however the height of the sheer face shall not exceed 1.2 m in height, and the height of a snow storage pile cannot exceed its width.

Volume Calculation

The volume of a snow storage polyhedral with 1:1 slopes, laying on a *rectangular* surface can be represented by the following formula:

$$V = \frac{W^2}{12} (3L - W) \quad (11.4)$$

Where:

V = Volume of snow, in cubic meters

W = Width (shortest edge) of the polyhedral base, in meters

L = Length (longest edge) of the polyhedral base, in meters

If the polyhedral utilizes 1.2m high sheer faces then volume would instead be:

$$V = \frac{W^2}{12} (3L - W) + 1.2LW \quad (11.5)$$

And shall that polyhedral lie on a surface with an existing snowfall accumulation, the effective storage volume of the polyhedral becomes:

$$V = \frac{W^2}{12} (3L - W) + (1.2 - SA)LW \quad (11.6)$$

These equations may be used for volume calculations in rectangular storage areas. Rectangular storage areas with slight curves or trapezoidal shapes may also use these

calculations, utilizing average lengths/widths, however snow storage piles on surfaces with complex geometries may require the use of CAD modeling tools.

11.2.3.2 LANDSCAPED BOULEVARDS

Landscaped boulevards act as an area for snow storage. If the Development exists on a street classified as a Collector or Arterial, then Designer shall account for snow storage on these boulevards. Sheer faces cannot be used in the snow storage area of a boulevard. The 1:1 side-slopes result with a snow volume represented by the following equation:

$$V_B = \frac{1}{4} W_B^2 \quad (11.7)$$

Where:

V_B = Volume of snow in the boulevard, in cubic meters per meter (m^3/m) of length of the boulevard

W_B = Width of the boulevard, in meters

11.2.3.3 MEDIANS

Medians (landscaped and/or concrete) are not used for snow storage. It is recognized however, that snow is not typically plowed from the median. When calculating the area for snow accumulation the area of the median shall be omitted.

11.2.3.4 FENCES

Fences must be taken into consideration when designating snow storage areas. If an area is planned to be fenced off, or could possibly be fenced off in the future, these areas shall not be designated as snow storage areas for City use unless it is fenced for the sole purpose of Regional snow storage. Fences shall be set back to allow for snow storage, as per the City of St. John's Development Regulations. They may be required to be set back even further should snow storage or traffic requirements dictate. Fences may also be required to secure a snow storage site.

11.2.3.5 ACCESS TO OTHER INFRASTRUCTURE

Access may need to be maintained to other infrastructure planned for the Development. Areas such as walking trails, community mailboxes, and fire hydrants will need to be accessible and shall not be used for snow storage. These areas will require a break in the snow piles while still maintaining the required snow storage for the street. While walking trails and community mailboxes must show a break in snow storage equal to the width of the trail or mailbox, fire hydrants will require a break in snow storage equal to 1 m total (0.5 m from the center of the hydrant). For calculation purposes, breaks in snow storage for walking trails shall be treated the same as a driveway, while breaks for mailboxes and hydrants will require the use of an "average" width and length of the snow storage area.

11.3 COMMERCIAL / INDUSTRIAL DEVELOPMENT

The snow storage design process is slightly different for a Commercial or Industrial development than it is for a Residential development. The existence of longer frontages and dedicated access aisles makes achieving a more consistent storage pile easier. Commercial and Industrial properties are more often cleared with heavier equipment than Residential driveways which makes moving snow around easier, but also results with conflicts between private snow clearing operations and City snow clearing operations. This design process confirms that enough area is allocated for the City's snow storage purposes and that private snow clearing operations do not interfere with the City's storage.

11.3.1 SNOW STORAGE PLAN

A Snow Storage Plan must be submitted for review and approval. The Snow Storage Plan shall as a minimum include the following information, with the appropriate dimensions indicated:

- I. Streets, including sidewalks;
- II. Building footprints;
- III. Parking areas;
- IV. Landscaped areas (which must include any trees or plantings, and must coordinate with the landscaping plans);
- V. Any infrastructure that cannot be used for snow storage such as fire hydrants, community mailboxes and walking trails;
- VI. Snow storage areas for City use; and
- VII. Snow storage areas for private use.

11.3.2 SNOW STORAGE DETAILS

Details of the snow storage areas must be submitted for approval. Depending on the size and complexity of the site, the snow storage details and the snow storage plan may be combined on one drawing, however a separate drawing may be required. Snow storage details shall include:

- I. Section views of the snow storage areas wherever there is a significant change in snow storage width;

- II. Section views of the snow storage areas wherever there is a sloped surface, retaining wall, or grade change;
- III. Section views wherever there are trees or other landscaping features impacted by the stored snow; and
- IV. Calculations for the snow storage areas shall be shown on the drawing or submitted on a separate 8.5" x 11" sheet.

11.3.2.1 VOLUME OF SNOW TO BE STORED FOR CITY USE

The volume of snow cleared from the City street, *per meter of street length*, is equal to the SA (in m^3/m^2) multiplied by the width of the street to be cleared. The width cleared shall be interpreted as follows:

- I. Half the width of the City street Right-Of-Way in the case of streets classified as Arterial or Collector, as well as Local streets that may occur in a school zone;
- II. Half the carriageway (curb face to curb face) in the case of streets classified as Local that are not in a school zone;
- III. In the case of cul-de-sacs, the bulb portion of the cul-de-sac has a larger area of asphalt to be cleared of snow. This is accounted for accordingly with this calculation, and the carriageway is taken as the full diameter of the cul-de-sac bulb. Half of that carriageway would then be equal to the radius of the cul-de-sac bulb, which is typically 15.25 m;
- IV. As per Section 11.2.3.3 on medians, if a median is present in a roadway, this area shall be omitted from the calculations.

The total volume to be stored for City use (V_C) must be stored uniformly along the edge of the City Right-Of-Way in the appropriate geometry as per Section 11.2.3.1. As there is snow accumulation in the area where snow is to be stored, this additional accumulation must also be included with this pile. The simplest way to account for this is to include an existing snow depth equal to the SA depth over the snow storage area, in which the snow storage pile would be placed on top. This removes available sheer face volume as the maximum total sheer face, including the existing snow accumulation is 1.2m.

Any excess snow storage space will not result in a decrease in setback requirements indicated in the City of St. John's Development Regulations.

11.3.2.2 VOLUME OF SNOW TO BE STORED FROM THE PRIVATE DEVELOPMENT

Areas must be shown on the Snow Storage Plan that indicate where the Developer will store the snow from within the private Development. Snow would typically be cleared from asphalt parking areas and access aisles and pedestrian walkways and corridors.

Private businesses may not wish to store snow on their property during the full winter and may wish to avail of snow removal services, so Developers will not be asked to size the snow being stored in the Private Development. However, even if snow is to be disposed of instead of stored, some areas shall be designated to be used for snow storage as snow will need to be temporarily stored until it can later be removed.

For these reasons, calculations will not be required to be shown for within the Private Development for snow storage, but snow storage areas need to be indicated on the plans.

11.3.2.3 SAMPLE CALCULATION

A proposed Commercial Development is fronting a street classified as a Collector, with a Right-Of-Way width of 17.5 m. The highest elevation of the site is 80 m and the lowest elevation is 75 m. The total area of parking stalls, access aisles and concrete walkways is 9000 m². There are two access points connecting to the City road, with a combined width of 40 m.

Determine Snowfall Accumulation (SA)

$$\text{Elevation} = \frac{80+75}{2} = 77.5\text{m} \quad \text{SA} = \frac{E+195}{450} = \frac{77.5+195}{450} = 0.61 \text{ m}^3/\text{m}^2$$

This snowfall accumulation at this location is 0.61 m³/m², for design purposes.

Determine Volume of Snow to be Stored for City Use

$$V_C = \left(0.61 \frac{\text{m}^3}{\text{m}^2} \times \frac{17.5\text{m}}{2} \right) = 5.34 \text{ m}^3/\text{m}$$

The landscaped area adjacent the roadway must store 5.34 m³ on every meter of frontage in addition to the 0.61 m³/m² of snow that accumulates on this landscaped area.

11.3.2.4 LANDSCAPING CONFLICTS

Snow Storage Plans must include some basic details from the Landscaping Plans, most notably the location of existing and/or proposed trees and shrubs. Areas where new plantings exist shall not be used for snow storage as the pushing and shoving of snow

often damages or kills new trees and shrubs. Also, the snow piles can contain high amounts of salt which will also harm landscaping.

11.3.2.5 DRAINAGE

Storage piles for the snow from the Private Development must be located in an area so that melt water from the snow does not drain into the roadway or adjacent properties. This avoids the situation where meltwater is draining across sidewalks, which can freeze and cause a safety hazard for pedestrians using the sidewalks.

11.3.2.6 SNOW STORAGE AGREEMENT

Commercial Developers will be required to sign a snow storage agreement with the City, specifying that snow from the Private Development will not be stored in the areas designated and designed for City use. This is to avoid potential conflicts over snow storage space in the future.

11.4 RESIDENTIAL DEVELOPMENT

The snow storage design process is slightly different for a Residential development than it is for a Commercial or Industrial development. Frontages are smaller and snow storage space is broken up by driveway entrances. Residential driveways are often cleared by hand or with small personal snowblowers, which limits the ability to easily move snow around. This design process combines the City's snow storage requirements with the Residential Homeowner's snow storage requirements to provide an adequately spaced shared snow storage area in the Homeowner's front yard.

11.4.1 SNOW STORAGE PLAN

A Snow Storage Plan must be submitted for review and approval. The Snow Storage Plan shall be designed to resemble a storm or sanitary drainage plan and shall generally include the following information, with the appropriate dimensions indicated:

- I. Streets, including sidewalks;
- II. Footprint of proposed houses;
- III. Driveways;
- IV. Front lawns;
- V. Any infrastructure that cannot be used for snow storage such as fire hydrants, community mailboxes and walking trails;
- VI. Delineated snow accumulation areas; and

VII. Snow Storage Piles.

11.4.2 SNOW STORAGE DETAILS

Details of the snow storage areas must be submitted for approval. Depending on the size and complexity of the site, the snow storage details and the Snow Storage Plan may be combined on one drawing, however a separate drawing may be required. Snow storage details shall include:

- I. Section views of the snow storage areas wherever there is a sloped surface, retaining wall, or grade change;
- II. Section views wherever there are trees or other landscaping features impacted by the stored snow; and
- III. Calculations for the snow storage piles shall be submitted in a separate excel spreadsheet.

11.4.3 SNOW ACCUMULATION AREAS

Snow accumulation areas must be delineated for each snow storage area (typically a Residential front yard). There should only be one snow accumulation area for each snow storage area, and only one snow storage area for each snow accumulation area.

The boundaries for the accumulation areas should be delineated by the positioning of driveways, not by actual property boundaries. When extending accumulation area boundaries from the curb to the centerline, the boundary should be perpendicular to the curb.

Snow storage areas between adjacent homes can share the storage area between two driveways. This is encouraged and results with larger snow storage piles.

Thin landscaped buffers between adjacent driveways have little to no snow storage capacity and should not be considered a storage area requiring a delineated accumulation area. These areas would be treated as a hardscape to be cleared and the edge of a delineation area would go through the middle of the buffer.

Each accumulation area should be delineated as follows:

- I. From the centerline of the road (or the center point of a cul-de-sac bulb) to the building footprint (or 10 m from the face of curb, whichever is less) in one direction;
- II. From the center of one driveway to the center of the next driveway.
Shared/adjacent driveways should be treated as one driveway (even if there is a small buffer in between), with the accumulation area delineated in the middle of the shared/adjacent driveway;

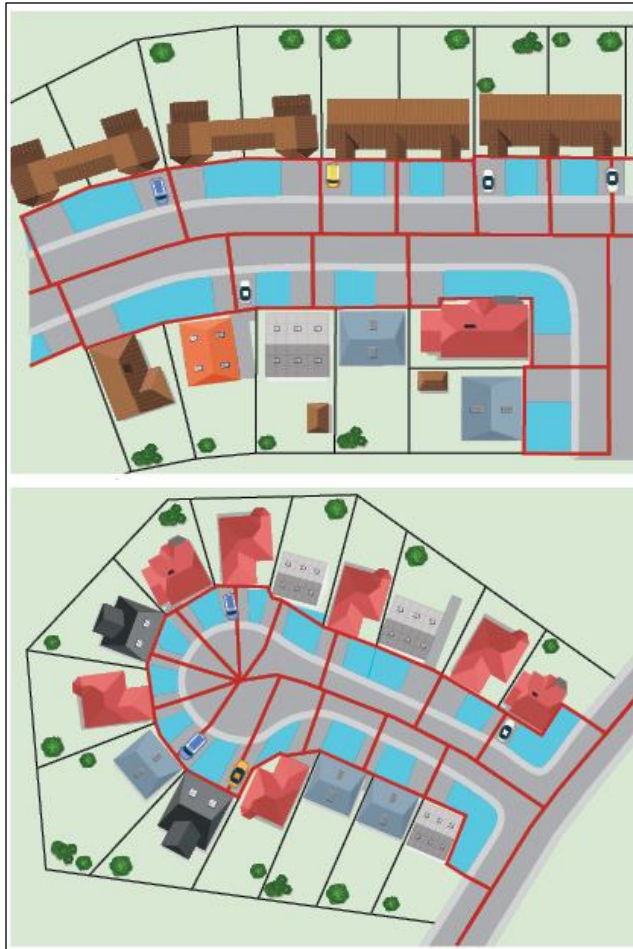

Figure 11-4 - Snow Storage Areas shown in Blue; Snow Accumulation Areas outlined in Red

The total area in each snow accumulation area must be multiplied by the snow accumulation value for the elevation of the road directly in front of the snow storage area. This will yield a total volume that must be stored in the snow storage areas in front of each residence. The City can provide a calculation template to Developers upon request.

11.4.5 SNOW STORAGE PILE LOCATIONS

Each snow storage pile must be situated between the residence and the roadway but shall be no further than 10 m from the face of curb. Areas further than 10 m from the curb are of little use to City operations. Sidewalks may be utilized for snow storage space if the roadway is classified as a Local or Residential street and is not in a school zone. Shall the street be in a school zone or be classified as a Collector or Arterial then the snow storage pile must not be shown situated on the sidewalk. Besides sidewalks on Local streets, storage piles shall not be situated on any hardscapes, including driveways and walkways.

11.4.6 CONTROLLING RESIDENTIAL HARDSCAPES

Residential hardscapes will be strictly controlled. Driveways approved at a certain width may not be widened at any point of the driveway without express approval by the City.

Previous City landscaping and driveway width requirements on occasion resulted with driveways installed in triangular shapes, or with other hardscapes installed alongside the driveway. This practice severely impacted snow storage. Driveway widths must remain consistent within the 10 m setback from the face of curb, at the width approved in the Snow Storage Plan, unless it can be shown that there is adequate snow storage in the landscaped areas.



Figure 11-5 - Examples of Unacceptable Driveways

Note:

Left: Triangular driveway with reduced snow storage – not acceptable.

Center: Triangular driveway widened with an adjacent walkway – not acceptable.

Right: Driveway with consistent width but installed wider than approved – not acceptable.

11.5 SNOW DRIFTING

Developers are required to manage/mitigate any snow drifting which cause operational issues for the City due to the clearing of land. Failure to meet City requirements may result in the City undertaking such work at the cost to the Developer. Snow drifting mitigation measures shall be undertaken in accordance with

https://sicop.transportation.org/wp-content/uploads/sites/36/2017/07/NCHRP-20-07147_Controlling-Blowing-Snow-Snow-Fence_Tablet_2003.pdf

12 FLOODPLAINS

Floodplains are associated with rivers or streams and, within the City of St. John's, floodplains shall be calculated for watercourses that either contain a continuous flow of water throughout each season of the year or drain a large enough catchment that, in the sole opinion of the City, would generate a significant area of inundation during the wet seasons. Floodplains may not be calculated for swales, drainage ditches, or any other open channel that does not meet the above criteria.

Floodplains within the City of St. John's can be delineated by the Provincial Department of Environment and Climate Change, the City of St. John's, or the Developer when expressly required by the City.

Floodplains shall be computer modeled using appropriate City-approved software that is capable of modeling gradually varied, unsteady flow. Floodplains models and the delineated floodplain may be deemed unacceptable unless they are calibrated based on: field-measured tipping bucket rainfall data; field-measured river flow monitoring data; and the models have been calibrated for at least three extreme rainfall/runoff events each with an 85% accuracy or better. Where no flow monitor data exists then models may be calibrated based on other calibrated models from other City river systems.

12.1 FLOODPLAIN MODELLING STUDY PROCEDURE

There are 11 steps involved in a floodplain study which are stated below and defined in subsequent sections:

- I. Define Study Objectives;
- II. Define Study Phases;
- III. Site Visit and Field Survey;
- IV. Determine Type of Hydrologic/Hydraulic Modeling that is Required;
- V. Data Requirements;
- VI. Define Hydrologic Modeling Procedures;
- VII. Data Entry, Base Model and Calibration;
- VIII. Verification;
- IX. Climate Change Model;
- X. Scenarios; and
- XI. Study Report.

12.1.1 STUDY OBJECTIVES

The primary objective will always be the delineation of the floodplain boundary. Other objectives may be: evaluating changes to river system capacity through sediment transportation, climate change and impacts of conveyance structures, or evaluation of other physical river changes; water quality assessment; velocity changes and erosion

evaluation; capital works forecasting; and flood analysis and/or remediation.

The objectives influence the type of analysis that will be required and the level of detail needed.

12.1.2 STUDY PHASES

The three phases of a study are: (i) preliminary; (ii) feasibility; and (iii) detailed design and they are briefly discussed here:

12.1.2.1 PRELIMINARY

The preliminary stage involves a rough estimate of the floodplain using simple hand techniques to get a “ball park” idea concerning the area of inundation. This would be coupled with an initial site visit and a cursory analysis of aerial and contour mapping.

12.1.2.2 FEASIBILITY

The bulk of the hydrologic and hydraulic modelling is done during this stage. The floodplain is established with a calibrated model and the capacity of any conveyance structures is determined. Areas of inundation are defined and locations requiring remediation and/or upgrading become known. With the study objectives being closer to realization the next section deals with the actual designs.

12.1.2.3 DETAILED DESIGN

The detailed design focuses on the hydraulic and structural design of the items identified in the study objectives and the feasibility phase. This could include design of: levees; stormwater detention; channel improvements; bridge/culvert upgrades; erosion and scour protection; spillway or control structures; or fish habitat improvements. Additional modelling is required here to evaluate the design and to explore alternative scenarios.

12.1.3 SITE VISIT AND FIELD SURVEY

The modeling of a river cannot be appropriately achieved without conducting site visits. Over the course of the study the Hydrologic/Hydraulic Engineer should visit the site on several occasions to perform field reconnaissance. For long river systems, it is recommended to use two vehicles system of visiting the river in sections with a team of two or three individuals. Take lots of photos and videos along the river. Note all river uniformity, meandering, bridges, outfalls, sewer crossings, instream structures and obstructions (man-made and natural), areas of erosion and scour, siltation, channel bed material, riverbank vegetation, tributaries, and high-water marks.

Determine in the field what you need surveyed and then have a Professional Surveyor acquire all elevations and dimensions along with northing and easting coordinates. Channel cross-sections will be required - even if LiDAR is being used.

12.1.4 TYPE OF HYDROLOGIC/HYDRAULIC MODELING

It's very simple these days to do 2D or 1D/2D modelling but in many cases it is overkill and a simple 1D model is adequate. Table 12-1 lists some general guidelines for analysis procedures for various types of hydraulic interest.

Table 12-1 - Type of Hydraulic Modeling

Item	Typical Modeling Procedure
River Flows	GVSF – 1D analysis
Floodplain – Straight river, no tributaries, no overtopping of riverbanks	GVSF – 1D analysis
Floodplain - Straight river, with tributaries, no overtopping of riverbanks	GVUF – 1D analysis
Floodplain - Straight river, with tributaries, with riverbank overtopping	GVUF – 1D/2D analysis
Bridge/Culvert upgrading – No backwater	Inlet & Outlet Control Nomographs
Bridge/Culvert upgrading – With backwater	GVSF – 1D analysis
Stormwater Detention	GVUF – 1D analysis
Channel Modifications	GVSF – 1D analysis
Channel Diversions/Bypass	GVSF – 1D analysis
Confluence Analysis	GVSF – 1D analysis
Weir/Spillway	GVSF – 1D analysis
Erosion and Scour	GVSF – 1D analysis
Dam (Height ≤ 2.4m)	GVSF – 1D analysis
Dam (Height >2.4m)	GVSF – 1D analysis + Dambreak

GVSF = Gradually Varied Steady Flow; GVUF = Gradually Varied Unsteady Flow

12.1.5 DATA REQUIREMENTS

This step determines how much data is available and what additional amount is needed. In addition to the field data collected in Section 12.1.3, the primary types of additional data that will be needed are: (i) Rainfall data; (ii) River flow data; (iii) LiDAR data; (iv) Photos; (v) Previous studies; and (vi) Interviews with local residents.

12.1.5.1 RAINFALL DATA

There are two set of data required: (i) tipping bucket rainfall for extreme rainfall events for calibration; and (ii) rainfall hyetographs for design that account for climate change.

Tipping Bucket Rainfall Data

Continuously recorded tipping bucket rainfall data is available from the City's rain gage stations at Windsor Lake, Blackler Avenue, and Ruby Line. The rainfall is recorded for each minute of a precipitation event and can be summated into 5-minute intervals for modeling. There are a number of events over the last 35 years that caused significant flooding and would be of interest for calibration, some of which are listed in Table 12-2.

Table 12-2 - Potential Rainfall Events for Calibration

Date	Description	Total Rainfall (mm)	Duration (hours)
April 11, 1986		71	24
September 19, 2001	Tropical Storm Gabrielle	147	12
November 16, 2004		72	12
April 11/12, 2005		99	24
August 2, 2007	Tropical Depression Chantal	104	12
November 29, 2008		75	12
September 21, 2010	Hurricane Igor	175	12

The August 2, 2007 event is good choice for calibrating the impermeable areas contribution to runoff since this event occurred during a very dry period of the summer with no antecedent moisture. The September 21, 2010 event is the "gold standard" for calibration since it was the largest event on record, it exceeded the 100-year projections at that time, and all pervious and impervious areas that could contribute to runoff were active during the event.

Rainfall Hyetographs (adjusted for Climate Change)

The 100-year cumulative rainfall hyetographs with climate change are shown in Table 12-3 for the 30-minute, 1-hour, 2-hour, 6-hour, 12-hour, and 24-hour events. These events would be input into a calibrated hydrologic/hydraulic model to predict future climate change runoff which included climate change.

Table 12-3 - Rainfall Hyetographs with Climate Change (100-year)

Time (%)	30-Min. (mm)	1-Hour (mm)	2-Hour (mm)	6-Hour (mm)	12-Hour (mm)	24-Hour (mm)
0.00	0.0	0.0	0.0	0.0	0.0	0.0
8.33	3.5	4.5	5.8	8.8	1.8	14.0
16.67	8.7	11.1	14.5	22.0	3.5	35.1
25.00	15.4	19.8	25.6	38.9	12.2	62.3
33.33	24.1	31.1	40.2	61.2	31.1	97.9
41.67	34.5	44.4	57.5	87.7	65.7	140.1
50.00	42.6	54.8	70.9	108.1	109.0	172.7
58.33	45.4	58.4	75.5	115.0	140.3	183.7
66.67	47.5	60.9	78.8	120.1	157.6	192.1
75.00	49.1	63.2	81.6	124.4	166.2	198.9
83.33	50.2	64.7	83.5	127.3	169.6	203.6
91.67	50.8	65.3	84.5	128.8	171.4	205.8
100.0	51.1	65.7	85.0	129.5	173.1	207.0

Time is given as a percentage of the duration of a given rainfall event. When applied to the 30-minute event, for example, the following hyetograph would be entered into the model.

Table 12-4 - 30-Minute Rainfall Hyetographs with Climate Change (100-year)

Time (min.)	0.5-Hour (mm)
0.0	0.0
2.5	3.5
5.0	8.7
7.5	15.4
10.0	24.1
12.5	34.5
15.0	42.6
17.5	45.4
20.0	47.5
22.5	49.1
25.0	50.2
27.5	50.8
30.0	51.1

12.1.5.2 RIVERFLOW DATA

River flow data will primarily come from the Government of Canada's Water Survey of Canada website: www.Canada.ca/en/environment-climate-change/services/water-overview/quantity/monitoring/survey.html. Real-time data is available under "Real-Time Hydrometric Data" and archived data is available under "Historical Hydrometric Data".

There are presently three active hydrometric stations in St. John's as listed in Table 12-5 followed by four stations that are inactive but have data for the years indicated.

The maximum instantaneous flows for each year can be viewed from this database and then hourly data can be requested from Environment and Natural Resources for calibration purposes.

Table 12-5 - Environment Canada Hydrometric Stations

Station Name	Station Number	Station Coordinates	Year with Data
Active			
Learys Brook at Prince Philip Drive	02ZM020	47°33'51" N 52°44'54" W	1985-2021
Virginia River at Pleasantville	02ZM018	47°35'20" N 52°41'26" W	1984-2021
Waterford River at Kilbride	02ZM008	47°31'44" N 52°44'42" W	1974-2021
Inactive			
Learys Brook at St. John's	02ZM017	47°33'43" N 52°45'47" W	1993-1998
Virginia River at Cartwright Place	02ZM019	47°36'06" N 52°42'06" W	1985-1998
Waterford River at Mount Pearl	02ZM010	47°31'21" N 52°48'32" W	1981-1996
Waterford River near Donovans	02ZM011	47°31'41" N 52°49'42" W	1981-1984

12.1.5.3 LIDAR DATA

LiDAR (name originates from the words Light and Radar) is a remote-sensing technique that uses light (in the form of a pulsed near-infrared [1040-1060nm] laser) to measure variable distances to the earth. Airplanes are the most common means of acquiring LiDAR data over large areas using a laser, a scanner, and a special GPS receiver. Precise 3D geometric information about the earth's surface is acquired through LiDAR including ground elevations.

The City regularly arranges an aircraft equipped with LiDAR surveying technology to fly over the City and acquire geospatial information. That data is then converted to digital elevations with a resolution of 0.7 meters. The LiDAR information has a high degree of accuracy and can be the prime survey information for modeling. LiDAR is supplemented by measurements and elevations acquired through a field survey. Usually several river cross-section will be surveyed for comparison with the LiDAR data. Dimensions and elevations of bridges and culverts will also need to be surveyed in the field.

12.1.5.4 PHOTOS

Photos can be of great assistance to the modeling process providing a glimpse in time of the river's water levels during a runoff event. The City has a digital archive that spans 20-years. Each photo is time and date stamped and can be easily matched to the timing of a recorded rainfall or streamflow event.

Historical photos from newspapers, archives, and personal collections can also be of use and the Modeller is encouraged to seek these out wherever possible. The confidence in a hydraulic model will be greatly improved if there are photos available to compare with modelling results.

12.1.5.5 PREVIOUS STUDIES

If there are previous hydrologic and/or hydraulic studies for the river being modelled then it is imperative that the older studies be reviewed. Previous studies have a wealth of information. They may use different modeling approaches or analytical techniques that offer a different point of view. They may contain input data that is applicable for the current study. There may be previous surveys or interviews with residents as well as photos and highwater marks. Lastly, there will be drainage areas, flows, and water surface profiles that will be of great assistance.

12.1.5.6 INTERVIEWS

During the numerous site visits that the Modeller will perform, it may be beneficial to speak with local residents who lived in the area during some extreme runoff events. Local people can be your best source of information and can often provide that illusive snapshot of a flood event that never found its way into a public forum. Some residents' properties will have concealed highwater marks from flood events that you would not see during a walk along the river.

12.1.6 HYDROLOGIC MODELING PROCEDURES

The modeling techniques to be used in study will be determined in this step. For gradually varied steady flow (GVSF) modeling, the modeling procedures might include the following:

12.1.6.1 PRECIPITATION

Precipitation options will be related to choice of (i) constant time interval, (ii) variable time interval, or (iii) tipping bucket gage. In the case of (i) and (ii) the Modeller would have to decide if the rainfall would be entered as cumulative depth, absolute depth, or intensity.

12.1.6.2 INFILTRATION

Techniques which will be considered for infiltration are Horton's method, Green-Ampt method, Uniform Loss method, or SCS curve number method. Horton's method requires: a maximum infiltration rate, minimum infiltration rate, decay rate of infiltration, and maximum infiltration volume. The Green-Ampt method requires: the average capillary suction head, the initial moisture deficit, and the saturated hydraulic conductivity. The Uniform Loss method will need an initial loss and a continuing loss rate. The SCS curve number method requires a pervious area curve number and an initial abstraction.

12.1.6.3 RUNOFF MODELLING

Options for runoff modeling include unit hydrographs such as SCS method, Nash, Snyder, Alameda, Clark, Time Area, and Santa Barbara. Laurenson's method is also available for consideration along with the Kinematic Wave method.

12.1.6.4 HYDROGRAPH ROUTING

Typical routing methods available are: Muskingum, Modified Puls, Straddle-stagger, and Muskingum-Kunge.

12.1.6.5 CALIBRATION DATA

Although not a modeling technique, all calibration data shall be finalized at this point. Modellers need to ensure that all events that will be used for calibration have tipping bucket rain gage data and corresponding streamflow data. If highwater marks were surveyed in the field then they shall be collated with the aforementioned data in this step.

12.1.7 BASE MODEL AND DATA ENTRY

This is the most labor-intensive step in the study where the model network is set up, all data is entered, the model is debugged, and then the Modeller goes through the calibration process. Data entry includes, but is not limited to, all geometric data such as: river cross-sections; bridges, culverts, weirs, diversions, detention facilities, storm sewers, drainage ditches, spillways, dams and any other structure that would impact the analysis. Rainfall data, infiltration data, and calibration data are also input into the model.

The model is checked for data entry errors and are corrected. The model is then run initially to verify there are no missing parameters or model settings.

Once a working base model is established then the calibration process commences. The observed hydrographs for the various calibration rainfall events shall be entered in the model at the appropriate location, if the model supports that action. The computed

model hydrographs for the calibration events must be compared with their respective observed hydrographs. Both the peak and the volume of the computed hydrographs must be within 15% of the peak and volume of the respective observed hydrographs. When this is achieved for all calibration rainfall/runoff events then the base model is considered to be calibrated.

12.1.8 VERIFICATION

The floodplain elevations shall be checked with known highwater marks and the accuracy of the model's ability to replicate observed flood levels shall be verified.

An independent review of the base model for QA/QC purposes may be required to verify the base model.

12.1.9 CLIMATE CHANGE MODEL

The base model shall be run using the 100-year climate change rainfall hyetographs to create a climate change model and determine the climate change floodplains. The maximum floodplain from the 6 rainfall events shall be selected and the floodplain shall be plotted on the City's latest aerial mapping.

A sensitivity analysis shall be performed on the hydraulic parameters of the climate change model. As a minimum the 100-year flows and Manning's n shall be independently increased by 10%, 20%, 30% and the subsequent floodplains plotted. Likewise, the 100-year flows and Manning's n shall be independently reduced by 10%, 20%, 30% and the subsequent floodplains plotted. There will be at least 12 additional floodplains from this analysis indicating the sensitivity of the hydraulic parameters. Again, an independent review of the base model for QA/QC purposes shall be conducted to verify the climate change model.

12.1.10 SCENARIOS

In this step, proposed remedial work is evaluated and cost estimates determined for each alternative. Remedial work can be: bridge improvements or replacement; flood control through levees or berms, erosion and scour prevention; instream work, stormwater detention, and dam construction to name a few. Each scenario shall have a revised floodplain to reflect the impacts of the remedial work.

12.1.11 STUDY REPORT

The study report needs to be clear, concise, and describe all aspects of the study including assumptions. The report will start with an Executive Summary followed by a Table of Contents listing all sections, appendices, figures, tables, etc. The report shall provide a table of the 100-year flows at key points along the river along with the water surface elevation. Plots of the calibration hydrographs shall be provided superimposed over the observed hydrographs. A table shall be provided indicating the sensitivity

analysis. Sketches shall be provided for any proposed remedial work along with cost estimates. All floodplains shall be provided in the appendices. The report shall have a discussion and recommendations followed by a conclusion. The City may require the final draft report be independently reviewed for QA/QC purposes.

12.2 DEVELOPMENT WITHIN BODIES OF WATER AND BUFFERS

The City restricts development within waterways, wetlands, ponds, lakes, or buffers as described in the City of St. John's Development Regulations, with some exceptions at Council's discretion. Any development permitted by Council in a body of water or buffer must not interfere with the flow of water or the displacement of water such that it creates a worse flooding situation for other properties. In that regard, the City may require a Grading Plan indicating in sufficient detail, to the City's sole satisfaction, the existing and proposed elevations. The Grading Plan shall demonstrate that the pre-development flow patterns are maintained, that there is no significant change of grade, and that there is no redirection of flood waters onto other properties. The City will not permit mass excavation within a body of water or buffer to construct stormwater detention facilities.

Provincial (Environment and Climate Change) and Federal (Fisheries and Oceans Canada) approval are to be obtained and submitted for development in a body of water or buffer, where required by each authority.

13 COMMERCIAL DEVELOPMENT

For the purposes of this Division of the Manual, Commercial development will be defined as any Non-Residential development or development that is a Commercial operation. For example, an apartment building or a condominium may be a Residential development but it is a Commercial operation and is subject to the requirements of this Division.

13.1 APPROVAL-IN-PRINCIPLE

At the Approval-In-Principle stage the Development is reviewed in general terms. Site access and availability of services (i.e. water supply, sanitary sewer, storm sewer) are examined to determine if the Development can be accommodated.

To facilitate this the Developer is required to do the following:

- I. Submit a completed Development Application to the City and pay the application fee.
- II. Provide a current Legal Survey and Description which indicates all Easements and encroachments. The Legal Survey and Description shall have been prepared within the last 10 years and is accordance with this Manual.
- III. Submit a Site Plan indicating all existing and proposed infrastructure within and adjacent to the Development. The point of connection to the municipal services must be indicated on the Site Plan along with the proposed access.

The City will review the zoning for the proposed Development along with the capacity of municipal infrastructure and advise if there any issues with what is proposed. Any issues that arise must be dealt with by the Developer before the City's review can be completed. Approval-In-Principle is not required to proceed to Final Approval, but Final Approval will not be granted if the Approval-In-Principle is refused.

13.2 FINAL APPROVAL

The Developer can proceed to Final Approval after the Approval-In-Principle phase. The Developer can submit detailed drawings, calculations and reports to commence review for Final Approval. The Developer should be aware that a building permit will not be issued by Regulatory Services until the Developer has received Final Approval from the Planning and Development Division of PERS. Regulatory Services requires a separate application and review for the building structure and their comments must also be addressed prior to a building permit being issued.

The following items must be submitted as a minimum as part of the Final Approval process.

13.2.1 LEGAL SURVEY PLAN

A current Legal Survey Plan and Description along with Real Property Report must be submitted which meets the criterion set out in Division 2 of this Manual.

13.2.2 DETAILED SITE PLAN

The detailed Site Plan shall meet all requirements set out in Division 3 of this Manual and shall include, but is not limited to, the following:

- I. All existing and proposed boundaries and limits of construction;
- II. Footprint of proposed building(s) indicating dimensions from property lines. Indicate lowest floor and finished floor elevations for all structures.
- III. All entry points to building along with concrete walkways and concrete pads.
- IV. Existing and proposed elevations throughout the entire site shall be shown with proposed high and low points clearly indicated. Within parking lot areas catchbasins must be away from the curb. When catchbasins are used for stormwater management then the parking lot shall be bowl shaped or comprised of several bowl shapes with all catchbasins located in sags. An adequate number of elevations must be provided in order to establish drainage patterns. Parking lot grades shall not exceed 5%. Existing elevations shall be maintained along property boundaries.
- V. Parking lot layout with numbered parking stalls and stall and aisle widths indicated in meters. All curb radii and paraplegic ramps shall be labelled. The parking lot shall generally be required to have an asphalt surface and the asphalt shall be enclosed with concrete curb. The City may waive the concrete curb requirement in some areas of the Development based on the type of stormwater management system that is proposed.
- VI. The Development shall meet all accessible parking requirements. The Site Plan shall indicate the location and size of accessible stalls and note the locations of any barrier free signs. Refer to Section 5.8.3 for design details.
- VII. A buffer must be provided as per the City of St. John's Development Regulations. The buffer shall be dimensioned to the property boundary. Any onsite curb or structures (i.e. fence, retaining wall, etc.) shall also be dimensioned to the property boundary.
- VIII. Proposed onsite/private snow storage areas as well as snow storage areas along the frontage of the property for City use. This shall be done in accordance with Division 11 of this Manual.

- IX. The extents of all reinstatement. The minimum length of asphalt reinstatement within a City Right-Of-Way is 3 m and shall be across the full road width. If multiple cuts are proposed, the Developer may be required to grind and place surface asphalt between the cuts.
- X. Access point(s) including location, width, and alignment. Curb radii shall conform to Table 5-2. Sidewalk must be extended across the access point.
- XI. Accessible path from the sidewalk in street to the building entrance(s).
- XII. All existing and proposed watermain infrastructure. This would include, but not be limited to, watermains, water service laterals, hydrants, water meters and premise isolation, curb stops, valves, and tees. The location, diameter, material, and type of the aforementioned infrastructure shall also be noted. Any existing water infrastructure to be removed must be clearly noted on the Site Plan.
- XIII. It shall be noted whether or not the building(s) is to be constructed with a sprinkler system.
- XIV. All on-site hydrants. All points on the building shall be no farther than 90 m from a hydrant for non-sprinklered construction, and 45 m for sprinklered construction.
- XV. All existing and proposed sanitary sewer infrastructure. This would include, but not be limited to: manholes (indicate internal diameter, top elevation), sewer mains and service laterals (indicate inverts, diameter, length, slope, material, DR ratio, and flow direction arrows), cleanouts, and connections to existing manholes. Any existing sanitary sewer infrastructure to be removed must be clearly noted on the Site Plan.
- XVI. All existing and proposed stormwater management infrastructure. This would include, but not be limited to: manholes (indicate internal diameter, top elevation); catchbasins and ditch inlets (indicate internal diameter, top elevation, grate slope, sump elevation); sewer mains, catchbasin leads, culverts, weeping tile and service laterals (indicate inverts, diameter, length, slope, material, DR ratio, and flow direction arrows); stormwater detention and/or retention facilities; outlet control devices; emergency overflow routes and connections to existing manholes. Any existing stormwater management infrastructure to be removed must be clearly noted on the Site Plan. Note that all stormwater must be managed appropriately on the Development site.
- XVII. Any sanitary sewer service laterals with diameters greater than 100mm connecting to a sanitary manhole. All storm sewer infrastructure which discharges to a public storm sewer shall do so at a storm manhole.
- XVIII. The location of all watersheds, watercourses, water bodies, floodplains, wetlands, and their buffers.

- XIX. Retaining wall details, cross-sections, top and bottom elevations. Retaining walls greater than 600 mm high must have railing in compliance with the National Building Code. Details of the railing must be provided.
- XX. The locations of external garbage bins including dimensions from structures and details of concrete pad and enclosure. This shall conform to the Commercial Maintenance By-Law. Note that any enclosure shall be 7.6 m from the nearest building.
- XXI. The fire access through the Development and must include, as a minimum, the location, turning movements, and a minimum 6.0 m width.
- XXII. Existing and proposed Easements, Right-Of-Ways, shared accesses, maintenance agreements, and encroachments (onto any neighboring properties including the City). Legal documentation must be provided for all encroachments.
- XXIII. Location of all signs (i.e. stop signs, accessible parking, no entry, authorized vehicles only, etc.).
- XXIV. Any existing or proposed drainage ditches, swales or berms showing location, slope, and flow direction along with a cross-section detail including finishes.
- XXV. Any existing or proposed storm sewer headwalls along with top elevation, bottom elevation, and hand railing (if headwall height exceeds 0.6 m).
- XXVI. All existing and proposed utility poles and their guy wire anchors.
- XXVII. The proposed line painting within the City street Right-Of-Way to accommodate any accesses.
- XXVIII. Any Drive-Thrus along with queuing space and circulation pattern.
- XXIX. All loading bays including bay widths and overhead clearance.
- XXX. Any existing or proposed oil-grit separators and shall be connected to the sanitary sewer as per the National Building Code of Canada.
- XXXI. All transformers, generators, aboveground tanks and underground tanks/chambers.

13.2.3 TRANSPORTATION

All Commercial development must meet requirements of Division 5 of this Manual. All computations for transportation and traffic components of the Development shall be

provided for review. This would include spreadsheets, plan and profile drawings, detail plans, and any required traffic modeling.

13.2.4 STORMWATER MANAGEMENT

All Commercial development must meet requirements of Division 6 of this Manual. All computations for hydrologic and hydraulic components of the Development shall be provided for review. This would include spreadsheets, drainage area plan, plan and profile drawings, shape files, and detail plans. For sites that require stormwater detention or retention, a report will be required that clearly explains and details how the proposed Development stormwater discharge will be limited to pre-development runoff rates.

13.2.5 SANITARY SEWER SYSTEM

All Commercial development must meet requirements of Division 7 of this Manual. All computations for hydraulic components of the Development shall be provided for review. This would include spreadsheets, drainage area plan, plan and profile drawings, and detail plans.

13.2.6 WATER DISTRIBUTION SYSTEM

All Commercial development must meet requirements of Division 8 of this Manual. All computations for water distribution components of the Development shall be provided for review. This would include spreadsheets, plan and profile drawings, detail plans, and any required water distribution modeling.

13.2.7 LANDSCAPING AND SNOW STORAGE

All Commercial development must meet requirements of Divisions 9 and 11 of this Manual. A Landscaping Plan shall be provided which indicates, as a minimum, all proposed landscaping; identification of existing and proposed vegetation, shrubs and trees; and snow storage areas.

The Development shall comply with the City's street tree planting standards, including the planting of a minimum of one tree per eight meters of lot frontage.

13.2.8 EROSION AND SEDIMENT CONTROL

All Commercial Development must meet requirements of Division 10 of this Manual. An Erosion and Sediment Control Plan must be provided for review.

13.3 OCCUPANCY PERMIT

An occupancy permit is required before any Commercial building can be occupied.

The requirements listed in Section 1.3 must be met, in addition to the following:

1. All site work must be completed.
2. Developer must submit a letter from a Professional Engineer licensed to practice in Newfoundland and Labrador certifying that all site work has been completed according to the approved Site Plan and City Standards.
3. An inspection by the City will be carried out to confirm if all site work has been completed. If deficiencies are found in the servicing, occupancy will not be approved.
4. Temporary Occupancy may be granted only in exceptional circumstances with the approval of the Manager of Development Engineering. All outstanding work or deficiencies must be completed within two months of the issuing of a Temporary Occupancy permit. If, due to climatic conditions, the work cannot be completed, an extension may be granted to July 31 of the following year. All deficiencies must be resolved prior to full occupancy.

14 WETLANDS

Wetlands are commonly referred to as swamps, fens, mires, marshes, bogs, moors, sloughs, morasses, quagmires, muskegs, and peatlands. They occur along ponds, lakes, brooks and rivers, and in other areas where the groundwater table is close to the surface. For the purposes of this Manual, a wetland is defined as any land area equal to or greater than 100 square meters which is saturated with water long enough to promote wetland or aquatic processes, and the wetland shall be delineated using the methodologies contained herein.

Wetlands shall be classified in accordance with the “Canadian Wetland Classification System” (CWCS). Using the CWCS there are five wetland classes that will be considered in this Manual – bogs, fens, swamps, marshes, and shallow waters.

The physical boundary of any wetland shall be delineated using the 1987 “Corps of Engineers Wetlands Delineation Manual” and the 2012 “Regional Supplement to the Corps of Engineers Wetland Delineation Manual: Northcentral and Northeast Region”.

The *Wetland Ecosystem Service Protocol for Atlantic Canada (WESP-AC) for Non-tidal Wetlands*, Dr. Paul Adamus (2018) shall be used for performing the functional assessment of all wetlands. Furthermore, this method has been calibrated for Newfoundland and Labrador and the spreadsheet “**NL WESP-AC Non-tidal Calculator_Single Site_2021.xlsx**” shall be used in the wetland functional assessment. The “**City of St John’s Wetland Scoring and Ranking Spreadsheet 2021.xlsx**” shall be used to calculate an overall score and rank for each wetland. These spreadsheets can be provided by the City.

The wetland evaluation method used in this Manual is intended to identify and measure recognized values of wetlands. The method allows consideration of the relative value of different wetlands through the examination and ranking of a number of wetland functions.

The criteria for assigning wetlands to these value categories are based both on science and the City’s Stormwater Management Policy. Science enters into the criteria in the form of in-situ observations by a Wetland Assessor to generate scores representing the relative levels of 17 wetland functions. Policy enters the criteria through the establishment of an overall wetland score and rank based on the City’s Stormwater Management Policy and this Manual.

14.1 GENERAL

14.1.1 CANADIAN WETLAND CLASSIFICATION SYSTEM

The **Canadian Wetland Classification System** contains two hierarchical levels: (a) class, and (b) form, with some forms subdivided into types based on vegetation characteristics.

14.1.1.1 WETLAND CLASS

The five classes of wetland are: bog, fen, marsh, swamp and shallow water.

Bog Wetland Class

A bog wetland is a peatland which has a raised or level surface which does not receive surface water runoff or groundwater from surrounding lands. Bog wetlands are primarily ombrotrophic which means that the majority of water derives solely from precipitation falling directly onto the bog. The water table within a bog wetland is at or just slightly below the surface of the bog. The water in a bog wetland is nutrient-poor and highly acidic with typical ranges between pH 4.0 and 4.8.

Fen Wetland Class

A fen wetland is a peatland which has surface water and groundwater movement. The surface of the fen is level with the water table. Unlike bogs, fens can receive surface water from upstream lands and groundwater flow and fens can discharge water to downstream areas through surface runoff and groundwater.

Swamp Wetland Class

A swamp is a forested wetland with over 30% cover from tall woody vegetation. In most areas of the swamp wetland the water table is below the ground surface. Swamp wetlands are comprised of highly decomposed woody peat and organic material. The nutrient regime is highly variable, ranging from above pH 7.0 to 4.5 or lower.

Marsh Wetland Class

Marsh wetlands contain shallow water which fluctuates throughout the year. Marshes receive water from the surrounding catchment primarily by surface water runoff and groundwater recharge. Typically, the water table remains at the surface. Marsh vegetation is comprised of rushes, reeds, grasses, sedges, and shrubs.

Shallow Water Wetland Class

Shallow water wetlands contain shallow water over more than 75% of their surface area but excludes artificial waterbodies such as reservoirs and impoundment areas where the water levels are regulated.

14.1.1.2 WETLAND FORM

14.1.1.2.1 *Bog Wetland Forms*

There are several bog wetland forms including: basin bogs; blanket bogs; collapse scar bogs; domed bogs; flat bogs; lowland polygon bogs; mound bogs; palsa bogs; peat mound bogs; peat plateau bogs; plateau bogs; polygon peat plateau bogs; riparian bogs; slope bogs; string bogs; and veneer bogs.

Basin Bogs

Basin bogs have a flat surface and they are primarily ombrotrophic, see Figure 14-1.



Figure 14-1 - Basin Bog

Blanket Bogs

Blanket bogs are large areas that include gentle slopes around valleys and hillsides, see Figure 14-2.



Figure 14-2 - Blanket Bog

Collapse Scar Bogs

Collapse scar bogs are depressions found in perennially frozen peatlands, see Figure 14-3.



Figure 14-3 - Collapsed Scar Bog

Domed Bogs

Domed bogs have a convex surface which is usually at least 500 m in diameter, see Figure 14-4.



Figure 14-4 - Domed Bog

Flat Bogs

Flat bogs occur in poorly defined lowland areas where sloping terrain is absent, see Figure 14-5.



Figure 14-5 - Flat Bog

Lowland Polygon Bogs

Lowland polygon bogs have convex or flat surfaces which are polygonal in shape. They are located in areas that are perennially frozen, see Figure 14-6.



Figure 14-6 - Lowland Polygon Bog

Mound Bogs

Mound bogs are up to 3 m in diameter and are discrete mounds of peat, see Figure 14-7.



Figure 14-7 - Mound Bog

Palsa Bogs

Palsa bogs are mounds of perennially frozen peat with a maximum diameter of 100 m, see Figure 14-8.



Figure 14-8 - Palsa Bog

Peat Mound Bog

Mound bogs are mounds of perennially frozen peat up to 3 m in diameter, see Figure 14-9.



Figure 14-9 - Peat Mound Bog

Peat Plateau Bog

Peat plateau bogs are perennially frozen peat and raised about 1m from the ground with sharply defined sides, see Figure 14-10.



Figure 14-10 - Peat Plateau Bog

Plateau Bog

Plateau bogs have a flat surface which is raised above the surrounding topography, see Figure 14-11.



Figure 14-11 - Plateau Bog

Polygonal Peat Plateau Bog

Polygonal peat plateau bogs are flat with polygonal patterns set in the permafrost, see Figure 14-12.



Figure 14-12 - Polygonal Peat Plateau Bog

Riparian Bog

Riparian bogs form along the edge of ponds and rivers, see Figure 14-13.



Figure 14-13 - Riparian Bog

Slope Bog

Slope bogs occur on sloping terrain, see Figure 14-14.

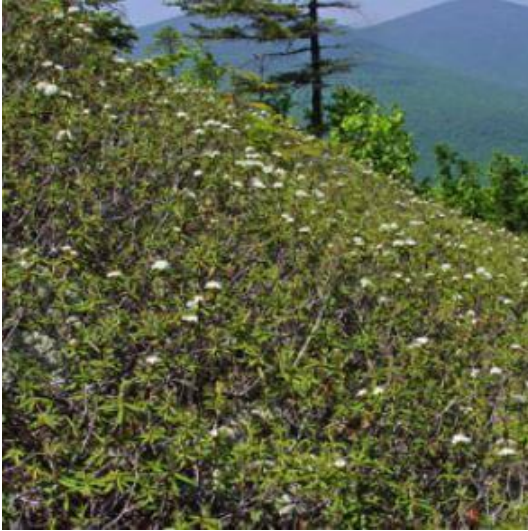

Figure 14-14 - Slope Bog

Veneer Bog

Veneer bogs are gently sloping to level terrain underlain by intermittent permafrost, see Figure 14-15.



Figure 14-15 - Veneer Bog

14.1.1.2.2 *Fen Wetland Forms*

Basin Fen

Basin fens are isolated from surface inflow and most of its water derives from direct precipitation and groundwater, see Figure 14-16.



Figure 14-16 - Basin Fen

Channel Fen

Channel fens are located within well-defined channels where there is no continuous river or stream flow activity, see Figure 14-17.



Figure 14-17 - Channel Fen

Collapse Scar Fen

Collapse Scar fens are small peatlands that were originally part of a palsa fen that through melting of the permafrost has caused the peatland to sink below the surrounding fen, see Figure 14-18.

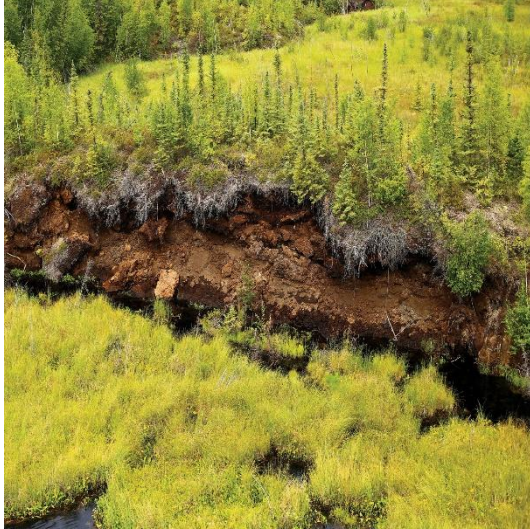

Figure 14-18 - Collapse Scar Fen

Feather Fen

Feather fens are located along narrow watercourses usually downslope from bogs, see Figure 14-19.



Figure 14-19 - Feather Fen

Horizontal Fen

Horizontal fens are broad depressions occurring on gentle slopes, see Figure 14-20.

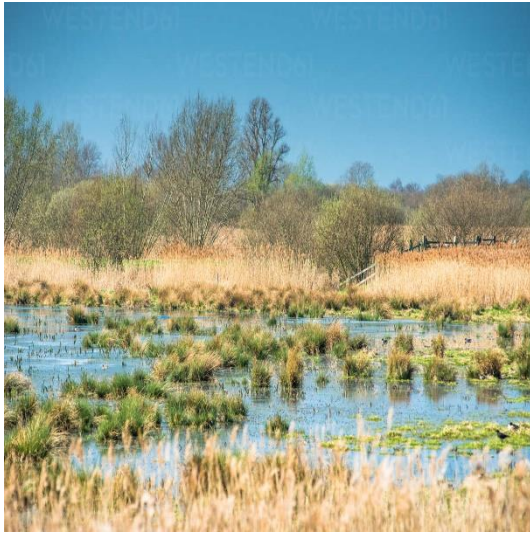

Figure 14-20 - Horizontal Fen

Lowland Polygon Fen

Fens located in lowlands that illustrate polygon cracking in permafrost terrain, see Figure 14-21.

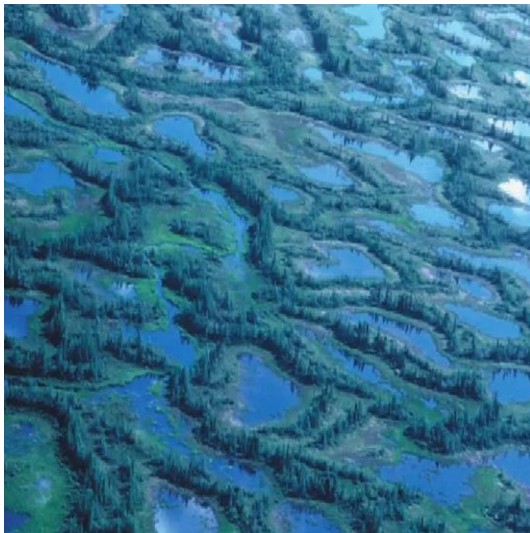

Figure 14-21 - Lowland Polygon Fen

Palsa Fen

Palsa fens are mounds of perennially frozen peat with diameters up to 100 m, see Figure 14-22.



Figure 14-22 - Palsa Fen

Riparian Fen

Riparian fens are located adjacent ponds and rivers as shown in Figure 14-23.



Figure 14-23 - Riparian Fen

Slope Fen

Slope fens are located on sloped locals usually ranging between 5 and 30 degrees, see Figure 14-24.



Figure 14-24 - Slope Fen

Snowpatch Fen

Snowpatch fen occurs on slopes below late-melting snowbanks in the Arctic wetland region, see Figure 14-25.



Figure 14-25 - Snowpatch Fen

Spring Fen

Spring fens are fed primarily by groundwater, see Figure 14-26.



Figure 14-26 - Spring Fen

String Fen

String fens are narrow, peaty ridges located on sloping terrain. They are orientated perpendicular to the direction of surface runoff and they function similar to check dams, see Figure 14-27.



Figure 14-27 - String Fen

14.1.1.2.3 *Swamp Wetland Forms*

Discharge Swamp

Discharge swamps are flat and occur at groundwater discharge locations that are adjacent or above a swamp, see Figure 14-28.



Figure 14-28 - Discharge Swamp

Flat Swamp

Flat swamps occur in depressions or defined basins, see Figure 14-29.



Figure 14-29 - Flat Swamp

Inland Salt Swamp

Inland salt swamps form along the periphery of inland salt ponds and wetlands, see Figure 14-30.



Figure 14-30 - Inland Salt Swamp

Mineral-Rise Swamp

Mineral-rise swamps occur on raised areas of mineral deposits, see Figure 14-31.



Figure 14-31 - Mineral-Rise Swamp

Raised Peatland Swamp

Similar to Mineral-Rise Swamps except these wetlands are raised by peatland and are located entirely in peatland terrain, see Figure 14-32.



Figure 14-32 - Raised Peatland Swamp

Riparian Swamp

Riparian swamps are located along rivers and ponds, see Figure 14-33.



Figure 14-33 - Riparian Swamp

Slope Swamp

Slope swamps slope downward towards rivers, ponds or other types of wetlands, see Figure 14-34.



Figure 14-34 - Slope Swamp

Tidal Swamp

Tidal swamps are located in areas influenced by tides, see Figure 14-35.



Figure 14-35 - Tidal Swamp

14.1.1.2.4 Marsh Wetland Forms

Basin Marsh

Basin marshes are located in depressions and receive waters from streams, surface runoff and groundwater, see Figure 14-36.



Figure 14-36 - Basin Marsh

Estuarine Marsh

Estuarine marshes are located in intertidal zones of estuaries where there is a major input of freshwater, see Figure 14-37.



Figure 14-37 - Estuarine Marsh

Hummock Marsh

Hummock marshes are perched above the groundwater table and may be located in depressions or on slopes, see Figure 14-38.



Figure 14-38 - Hummock Marsh

Lacustrine Marsh

Lacustrine marshes are freshwater marshes located along ponds and lakes, see Figure 14-39.



Figure 14-39 - Lacustrine Marsh

Riparian Marsh

Riparian marshes are located along rivers and streams, see Figure 14-40.



Figure 14-40 - Riparian Marsh

Slope Marsh

Slope marshes occur at the lower elevations of sloped terrain occupying wet seepage areas from groundwater, see Figure 14-41.



Figure 14-41 - Slope Marsh

Spring Marsh

Spring marshes occur along drainage ditches which receive seasonal runoff, see Figure 14-42.



Figure 14-42 - Spring Marsh

Tidal Marsh

Tidal marshes occur along the sea coast and they are either protected from wave action or located in areas where tidal changes are not too powerful, see Figure 14-43.



Figure 14-43 - Tidal Marsh

14.1.1.2.5 Shallow Water Wetland Forms

Basin Water

Basin water wetlands are comprised of either fresh or salt water and they occur in well-defined depressions, see Figure 14-44.



Figure 14-44 - Basin Water

Estuarine Water

Estuarine water wetlands are located primarily in shallow subtidal and intertidal zones of estuaries, see Figure 14-45.



Figure 14-45 - Estuarine Water

Lacustrine Water

Lacustrine water wetlands are located around freshwater ponds, see Figure 14-46.



Figure 14-46 - Lacustrine Water

Riparian Water

Riparian water wetlands are located along streams and brooks, see Figure 14-47.



Figure 14-47 - Riparian Water

Tidal Water

Tidal water wetlands occur along the seacoast, see Figure 14-48.



Figure 14-48 - Tidal Water

14.1.2 QUALIFICATIONS OF WETLAND ASSESSOR

Wetland delineation and functional assessment must be completed by an experienced environmental Assessor who has a combination of the following:

- I. Training in wetland delineation and functional assessment for Wetland Ecosystem Services Protocol for Atlantic Canada (WESP);
- II. Education and/or demonstrated experience in wetland hydrology, soils, botany and/or related sciences; and
- III. A minimum of 5 years wetland delineation and functional assessment field experience.

14.1.3 TIMING OF DELINEATIONS

Wetland delineation and functional assessments within the City of St. John's shall be done within the growing season typically between June 1st and September 30th. Due to the variation of ground conditions in any given year, the City may extend this time period.

14.2 WETLAND FUNCTIONAL ASSESSMENT METHOD

14.2.1 SCORING AND RANKING METHOD FOR WETLANDS

14.2.1.1 WEIGHTING AND SCORING

I. Scoring of the conditions of an indicator variable.

Table 14-1 lists one of the 17 function indicators used to establish a score for the Water Storage & Delay (WS) function – in this example the OF22 function indicator was selected. The last four rows in Table 14-1 describes the four possible conditions for the OF22 indicator.

Table 14-1 - Function Indicator OF22 for Water Storage & Delay (WS) Wetland Function - Blank Form

#	Function Indicator	Condition Choices	Data	Weight	Data x Weight	Standardise
OF22	Wetland is a % of its contributing area (Catchment)	From a topographic map and field observations, estimate the approximate boundaries of the catchment (CA) of the entire wetland of which the AA may be only a part. Then adjust those boundaries if necessary based on your field observations of the surrounding terrain, and/or by using procedures described in the Manual. Divide the area of the wetland (not just the AA) by the approximate area of its catchment excluding the area of the wetland itself. When doing the calculation, if ponded water is adjacent to				0.00

	the wetland, include that in the wetland's area. The result is:				
	<0.01, or catchment size unknown due to stormwater pipes that collect water from an indeterminate area.	0	0	0	
	0.01 to 0.1	0	1	0	
	0.1 to 1	0	2	0	
	>1 (wetland is larger than its catchment (eg. Wetland with flat surrounding terrain and no inlet, or is entirely isolated by dikes or is a raised bog)).	0	3	0	

The wetland Assessor selects the condition which best describes the wetland for this indicator by entering a "1" next to that condition in "Data" column of the spreadsheet, see Table 14-2. The relative weights of the four conditions are listed in the "Weight" column and these are "hard-wired" into the method and cannot be changed. The product of data and weight is automatically calculated in the "Data x Weight" column. The standardized score for OF22 appears in the "Standardize" column.

Table 14-2 - Function Indicator OF22 for Water Storage & Delay (WS) Wetland Function - Completed

#	Function Indicator	Condition Choices	Data	Weight	Data x Weight	Standardise
OF22	Wetland is a % of its contributing area (Catchment)	From a topographic map and field observations, estimate the approximate boundaries of the catchment (CA) of the entire wetland of which the AA may be only a part. Then adjust those boundaries if necessary based on your field observations of the surrounding terrain, and/or by using procedures described in the Manual. Divide the area of the wetland (not just the AA) by the				0.33

		approximate area of its catchment excluding the area of the wetland itself. When doing the calculation, if ponded water is adjacent to the wetland, include that in the wetland's area. The result is:				
		<0.01, or catchment size unknown due to stormwater pipes that collect water from an indeterminate area.	0	0	0	
		0.01 to 0.1	1	1	1	
		0.1 to 1	0	2	0	
		>1 (wetland is larger than its catchment (eg. Wetland with flat surrounding terrain and no inlet, or is entirely isolated by dikes or is a raised bog).	0	3	0	

In this example, the standardised score is the $1/3 = 0.33$ which is the maximum value from the "Data x Weight" column divided by the maximum value from the "Weight" column. Again, this formula is "hard-wired" into the **WESP-AC** method and cannot be changed.

II. Normalizing of WESP-AC Function Scores.

The **WESP-AC** spreadsheet automatically converts raw scores to a 0-to-10 scale based on the calibration wetlands for Newfoundland and Labrador.

III. Combination of Multiple Wetland Functions into Rating Categories

- a) For a given wetland, the **WESP-AC** spreadsheet summarizes wetland functions into 5 groups: Hydrologic, Water Quality Support, Aquatic Support, Aquatic Habitat, and Transition Habitat. The spreadsheet determines a single score for each group.
- b) The scores for these 5 wetland function groups are combined into a "relative value score" by performing a weighted average as follows:

Relative Value Score

$$\begin{aligned} &= 0.40(\text{Hydrologic}) + 0.30(\text{Water Quality Support}) \\ &+ 0.15(\text{Aquatic Support}) + 0.10(\text{Aquatic Habitat}) \\ &+ 0.05(\text{Transition Habitat}) \end{aligned}$$

- c) The resulting relative value scores that were above the 75th percentile in the frequency distribution of all wetlands relative value scores are ranked “High” functioning, between the 50th and 75th percentile are ranked “Moderate” functioning, between the 25th and 50th percentile are ranked “Low-Moderate” functioning, and scores below the 25th percentile are ranked “Low” functioning.

14.2.1.2 WETLAND FUNCTIONS

The following briefly describes the 17 wetland functions evaluated in the field.

Water Storage & Delay (WS)

The effectiveness of a wetland for storing runoff or delaying the downslope movement of surface water for long or short periods. There are 14 function indicators and 4 benefit indicators that must be evaluated for the WS function.

Stream Flow Support (SFS)

The effectiveness of a wetland for extending flow duration into the drier parts of a growing season. There are 6 function indicators and 2 benefit indicators that must be evaluated for the SFS function.

Water Cooling (WC)

The effectiveness of a wetland for maintaining or reducing temperature of downslope waters. There are 17 function indicators and 8 benefit indicators that must be evaluated for the WC function.

Sediment Retention & Stabilisation (SR)

The effectiveness of a wetland for intercepting and filtering suspended inorganic sediments, thus allowing their deposition, as well as reducing energy of waves and currents, resisting excessive erosion, and stabilising underlying sediments or soil. There are 18 function indicators and 11 benefit indicators that must be evaluated for the SR function.

Phosphorus Retention (PR)

The effectiveness of a wetland for retaining phosphorus for long periods (>1 growing season) as a result of chemical adsorption, or from translocation by plants to belowground zones with less potential for physically or chemically remobilizing

phosphorus into the water column. There are 21 function indicators and 10 benefit indicators that must be evaluated for the PR function.

Nitrate Removal & Retention (NR)

The effectiveness of a wetland for retaining particulate nitrate and converting soluble nitrate and ammonium to nitrogen gas, primarily through the microbial process of denitrification, while generating little or no nitrous oxide (a potent greenhouse gas). There are 29 function indicators and 16 benefit indicators that must be evaluated for the NR function.

Carbon Sequestration (CS)

The effectiveness of a wetland for retaining both incoming particulate and dissolved carbon, and through the photosynthetic process converting carbon dioxide gas to organic matter on a net annual basis for long periods while emitting little or no methane (a potent greenhouse gas). There are 121 function indicators that must be evaluated for the CS function.

Organic Nutrient Export (OE)

The effectiveness of a wetland for producing and subsequently exporting organic nutrients, either particulate or dissolved, along with associated compounds and elements such as iron. There are 19 function indicators that must be evaluated for the OE function.

Anadromous Fish Habitat (FA)

The capacity of a wetland to support rearing or spawning habitat of fish species that migrate from marine waters into freshwater streams to spawn. Catadromous species such as eels that spawn in marine waters but spend most of their life in fresh waters are also included. There are 26 function indicators and 4 benefit indicators that must be evaluated for the FA function.

Resident Fish Habitat (FR)

The capacity of a wetland to support an abundance and diversity of native fish (both resident and visiting species) that are not anadromous or catadromous (eg. Dolly Varden, cutthroat trout). There are 23 function indicators and 4 benefit indicators that must be evaluated for the FR function.

Aquatic Invertebrate Habitat (INV)

The capacity of a wetland to support or contribute to an abundance or diversity of invertebrate animals which spend all or part of their life cycle underwater or in moist soil.

Includes dragonflies, midges, clams, snails, water beetles, shrimp, aquatic worms, and others. There are 31 function indicators that must be evaluated for the INV function.

Amphibian & Turtle Habitat (AM)

The capacity of a wetland to support or contribute to an abundance or diversity of native frogs, toads, salamanders, and turtles. There are 37 function indicators and 4 benefit indicators that must be evaluated for the AM function.

Waterbird Feeding Habitat (WBF)

The capacity of a wetland to support or contribute to an abundance or diversity of waterbirds that migrate or winter but do not breed in the region. There are 28 function indicators and 7 benefit indicators that must be evaluated for the WBF function.

Waterbird Nesting Habitat (WBN)

The capacity of a wetland to support or contribute to an abundance or diversity of waterbirds that nest in the region. There are 34 function indicators and 4 benefit indicators that must be evaluated for the WBN function.

Songbird, Raptor & Mammal Habitat (SBM)

The capacity of a wetland to support or contribute to an abundance or diversity of native songbird, raptor, and mammal species and functional groups, especially those that are most dependent on wetlands and water. There are 31 function indicators and 5 benefit indicators that must be evaluated for the SBM function.

Pollinator Habitat (POL)

The capacity of a wetland to support or contribute to an abundance or diversity of insects, such as bees, wasps, flies, butterflies, moths, and beetles. There are 17 function indicators and 3 benefit indicators that must be evaluated for the POL function.

Native Plant Habitat (PH)

The capacity of a wetland to support or contribute to a diversity of native, hydrophytic, vascular plant species, communities, and/or functional groups. There are 41 function indicators and 3 benefit indicators that must be evaluated for the PH function.

15 STREAM CROSSINGS

Developments will often find it necessary to cross watercourses, rivers, streams, and brooks (for simplicity this Division will refer to all as “streams”). Such crossings have the potential to change the natural flow regime and negatively alter fish habitat. Improperly installed culverts and bridges can lead to erosion and sedimentation problems and create impediments to fish passage. The following instruction is provided for all stream crossings.

15.1 DESIGN

Developers shall design road networks primarily for linear development. Wetlands, floodplains, and their buffers shall be avoided.

The design of the stream crossing structure shall consider natural site features, hydraulic conditions at that site, the accommodation of the 100-year event and low flows, and the amount of environmental disturbance during construction.

The instream approaches to and discharge from the stream crossing shall be constructed with erosion resistant materials and approach grades shall be kept to a minimum for at least 20m on each side of the stream crossing.

Only natural bottom stream crossings will be approved in order to minimize alterations to fish habitat, flow regime, and avoidance of constrictions.

Stream crossings are to be modelled using the hydraulic and hydrologic conditions located in Table 12-1 and using a software approved by the City.

All stream crossings shall have approval from Provincial Department of Environment and Climate Change as well as Federal Fisheries and Oceans Canada.

15.2 SITE SELECTION

Examine proposed crossings that will provide the best features and conditions for the crossing. Assess the catchment and physical characteristics of the stream to determine the best location for the crossing.

Crossing locations shall be selected where the stream is straight, unobstructed, and well defined.

Crossings shall be located away and downstream from fish spawning sites or water-use intakes. The City, at its discretion, may permit a stream crossing within a sensitive fish habitat but the bridge shall be designed with a high elevation approach that spans the stream with no abutment encroachment into the stream corridor. Culverts shall not be permitted in these instances.

Crossings shall be located where possible effects on other hydraulic structures are avoided and with minimum risk of damage from floods.

15.3 GEOMETRY

Crossings shall be at right angles to the stream however, the City may permit a deviation from this requirement if, in the sole discretion of the City, it makes good Engineering sense.

15.4 GEOLOGY

Crossings shall be located in stable geological and soil conditions. A geotechnical report for new stream crossings shall be submitted to the City. This report shall be prepared by a Professional Geotechnical Engineer licensed to practice in the Province of Newfoundland and Labrador. The report shall demonstrate to City staff that the area of land is suitable for a stream crossing or the area of land can be made suitable. The report must also illustrate that the proposed stream crossing will not cause adverse effects or aggravate an existing condition within the proposed area or elsewhere.

15.5 BRIDGES

Bridges are the preferred stream crossing structure and especially in areas of known ice blockage or rapid runoff.

Concrete aprons under bridges shall not be permitted since fish passage can be impeded at low flows.

Bridge abutments shall be located outside the wetted perimeter of the stream for the 100-year event.

Instream piers shall be aligned with the streamflow and where required streambank protection shall be provided.

Bridges shall be constructed with wingwalls to minimize bank erosion.

Instream work shall be scheduled to avoid potential adverse impacts on spawning activities, spawning habitat, egg incubation, and fish migration.

All instream work shall be carried out in the dry and protocols must be in place to ensure no harmful substances enter the stream during construction.

Fill material for bridges shall not be taken from stream beds, banks or riparian areas.

Demolition of existing bridges shall be executed in such a manner that the bridge does not fall into the stream.

15.6 CULVERTS

Bottomless culverts are suitable for providing access over small streams. Culverts with bottoms will not be approved for salmonid bearing streams. Countersunk cylindrical culverts are not acceptable.

Culverts on stream crossings shall be designed to accommodate fish passage and a sufficient depth of flow and appropriate streamflow velocity for the various native fish species must be provided.

Culverts on stream crossings shall be designed to accommodate the 100-year flow and as well as the expected low flows.

Footings for bottomless culverts shall be installed outside the normal wetted perimeter of the stream and the footings shall be either anchored into the bedrock or sufficiently stabilized to prevent erosion around the footing or undermining.

To allow fish passage, bottomless culverts shall have minimum 1000 mm width and be designed/sized for the site specific hydrological and hydraulic conditions as per Table 12-1. Steep channels and/or high velocities may require an oversized culvert with fish baffles/weirs to allow for fish passage. Baffles are placed approximately 1 m from the inlet and outlet ends of the culvert with additional baffles placed accordingly so that maximum drop between adjacent baffles is 200 mm. Baffles will have a minimum 300 mm crest height above the culvert, a minimum notch width of 300 mm, and a minimum notch height of 200 mm.

Culverts shall be aligned parallel with the existing natural channel and be located on a straight section of stream with uniform slope.

A minimum water depth of 200 mm shall be provided throughout the culvert length. To maintain this water depth during low flows, an entrance and exit pool can be installed. Pools shall be designed to ensure a smooth transition of flow from the culvert to the natural stream width. Clean non-erodible riprap or gabions shall be used to stabilize the pool edges. The pool outlet may need to be V-notched to enable fish passage at low flows.

Pools shall be pear-shaped and sized such that pool length is 2-4 times culvert diameter, pool width is 2-3 times culvert diameter, and pool depth is 0.5 times culvert diameter with a minimum 1m depth.

The culvert slope shall follow the existing stream slope where possible.